



GAVA *plast*

*DVERNÉ VÝPLNE PRE PLASTOVÉ A HLINÍKOVÉ SYSTÉMY
DOOR-INFILL PANELS FOR ALUMINIUM & PLASTIC SYSTEMS
DIE TÜRFÜLLUNGEN FÜR DIE KUNSTSTOFF- UND ALUMINIUMSYSTEME
PANNEAUX DE PORTE POUR SYSTÈMES EN PLASTIQUE ET ALUMINIUM*

...od konceptu k detailu...



Sme radi, že Vám môžeme predstaviť naše produkty aj formou tohto katalógu. Sme GAVApplast, spoločnosť zameraná na dverné výplne a ich príslušenstvo s najdlhšou históriou výroby na Slovensku.

V tomto katalógu Vám prinášame realistickjšie vizualizácie jednotlivých modelov, čo so sebou prinieslo zväčšenie formátu katalógu.

Základné členenie je naďalej dané hlavnými produktovými líniami: GAVA hpl, GAVA plast, GAVA aluminium.

Okrem osvedčených modelov z minulého katalógu Vám predstavujeme až 120 nových modelov dizajnov, ktoré zhodnocujú naše súvislé dizajnové úsilie za posledné roky. Navyiac nově aj osvedčené modely výplní sme osviežili desiatkami nových dizajnov zasklení.

Našou snahou je predstaviť Vám nielen samotnú dvernú výplň, ale upriamujeme pozornosť na vstup do objektu ako celok.

Katalóg prináša viac technických informácií, ktoré Vám okrem dizajnu pomáhajú k správnym rozhodnutiam pri voľbe vhodného technického riešenia.

Nielen dizajnérské, ale i technické úsilie vývojového oddelenia prinieslo výsledky v podobe inovácií techniky jadra a inovatívnej koncepcie riešenia predsadených dverných výplní. Originalitu a prínos týchto riešení potvrdzujú priemyselné úžitkové vzory. Podrobnejšie technické informácie nájdete na našich webových stránkach.

Veríme, že okrem referencií či odporúčaní predajcov dverí, prispějú aj vyššie uvedené argumenty k Vášmu rozhodnutiu pre značku **GAVA**, ktorá je synonymom pre dvernú výplň.

...from concept to detail...



We are pleased also to introduce you to some of our products in this catalogue. GAVApplast is a company that focuses on the production of door panels and distribution of accessories. We are the company with the longest history of manufacture of this product in Slovakia.

The catalogue brings you a more realistic visualization of the different models, in addition to providing an enlargement of them.

Basic product lines continue to be divided between GAVA hpl, GAVA Plastic and GAVA Aluminium.

Besides the well-established models seen in the previous catalogue, 120 new models have been introduced that are the result of ongoing design efforts in recent years. On top of that, our new and proven panels have been enlivened with dozens of new glass designs.

While endeavoring to introduce you to door panels themselves, we would also like to draw your attention to how entrances to buildings should look as a whole.

This catalogue provides more technical information and compares parameters with each other, helping you to make correct decisions when you choose the appropriate technical solution alongside the design.

Our department is also striving both in terms of design and technically to bring results from our innovation of techniques and innovative design solutions for protruding door panels. The utilization of these models in industry confirms both the originality and benefits of these solutions. Detailed technical information can be found on our web pages.

In addition to references and recommendations from door vendors, we believe the reasons above will help you decide to go with **GAVA**, a brand synonymous with door panels.

...Vom Konzept zum Detail...



Wir sind froh, Ihnen unsere Produkte auch in Form dieses Katalogs vorstellen zu können. Wir sind GAVApplast, eine auf die Herstellung und Entwicklung von Türfüllungen und den Vertrieb von Zubehör ausgerichtete Firma. Wir sind die Firma mit der längsten Produktionsgeschichte bezüglich dieser Produkte in der Slowakei.

In diesem Katalog bieten wir Ihnen eine realistischere Visualisierung einzelner Modelle, was eine Vergrößerung seines Formats mit sich brachte.

Die grundlegende Gliederung erfolgt auch weiterhin nach den Hauptproduktreihen: GAVA hpl, GAVA plast, GAVA aluminium.

Außer bewährten Modellen aus dem letzten Katalog stellen wir Ihnen bis zu 120 neue Modelle vor, die unsere Design-Anstrengungen der letzten Jahre verwerten. Zudem haben wir auch bewährte Türfüllungs-Modelle mit Dutzenden neu designten Verglasungen aufgefrischt.

Unser Ziel ist es, Ihnen nicht nur allein eine Türfüllung vorzustellen, sondern die Aufmerksamkeit auf den Objekteingang als Ganzes zu lenken

Der Katalog bietet mehr technische Informationen und eine Gegenüberstellung von Parametern, die Ihnen neben dem Design bei der richtigen Entscheidung bezüglich der Auswahl der geeigneten technischen Lösung helfen.

Nicht nur designmäßige, sondern auch technische Anstrengungen unserer Entwicklungsabteilung brachten Ergebnisse in Form der Kern-Technik und einem innovativeren Lösungskonzept hervorstehender Türfüllungen. Die Originalität und die Vorteile dieser Lösungen werden durch industrielle Gebrauchsmuster bestätigt. Detailliertere technische Informationen finden Sie auf unseren Webseiten.

Wir sind überzeugt, dass außer Referenzen oder Empfehlungen der Türverkäufer auch die oben angeführten Argumente zu Ihrer Entscheidung für die Marke **GAVA** beitragen werden, die ein Synonym für Türfüllungen darstellt.

...du concept au détail...



Nous sommes heureux de pouvoir vous présenter nos produits également sous la forme de ce catalogue. Nous sommes GAVApplast, une société orientée sur la production et le développement de panneaux de portes et la distribution d'accessoires. Nous sommes la société ayant la plus longue histoire de production de ce produit en Slovaquie.

Dans ce catalogue, nous vous apportons des visualisations plus réalistes de chaque modèle, ce qui a entraîné un agrandissement de son format.

La segmentation basique est toujours formée par les principales lignes de produits: GAVA hpl, GAVA plast, GAVA aluminium.

Hormis les modèles éprouvés du dernier catalogue, nous vous présentons également 120 nouveaux modèles, qui valoriseront les efforts incessants que nous avons consacrés au design ces dernières années. De plus, nous avons également rafraîchi les modèles nouveaux et éprouvés de panneaux avec des dizaines de nouveaux designs de vitrage.

Nous nous efforçons de vous présenter non seulement un panneau de porte indépendant, mais consacrons également notre attention à l'entrée dans un bâtiment prise dans son ensemble.

Le catalogue apporte plus d'informations techniques et une comparaison mutuelle des paramètres, qui, hormis le design, vous aidera à prendre les bonnes décisions lors du choix d'une conception technique adaptée.

L'effort concernant le design mais aussi l'effort technique de notre service de développement ont apporté des résultats sous la forme d'innovations dans la technique du noyau et d'une conception innovante de résolution des panneaux de portes déplacés. Les échantillons industriels utilitaires confirment l'originalité et l'apport de ces conceptions. Vous trouverez des informations techniques plus détaillées sur nos pages web.

Nous espérons que, hormis les références ou recommandations des vendeurs de portes, les arguments susmentionnés contribueront également à votre décision en faveur de la marque **GAVA**, qui est synonyme de panneau de porte.

Obsah / Content / Inhalt / Contenu

Zoznam modelov / List of models / Modellverzeichnis / Liste des modèles	4
Jadro F / Core F / Kern F / Noyau F	6
GAVA HPL	8 - 41
Technické informácie / Technical information / Technische Informationen / Informations techniques	10
Farebné prevedenia / Colour options / Farbausführung / Versions colorées	12
HPL modely / HPL models / HPL Modelle / HPL modèle	14
GAVA PVC	42 - 83
Technické informácie / Technical information / Technische Informationen / Informations techniques	44
Farebné prevedenia / Colour options / Farbausführung / Versions colorées	46
PVC modely / PVC models / PVC Modelle / PVC modèle	48
GAVA AL	84 - 121
Technické informácie / Technical information / Technische Informationen / Informations techniques	86
Vložené a predsadené prevedenia / Composite door and Pre-installed door system designs / Eingelegte und vorstehende Ausführung / Versions insérées et saillantes	88
Farebné prevedenia / Colour options / Farbausführung / Versions colorées	90
AL modely / AL models / AL Modelle / AL modèle	92
Zasklenia / Glazing / Verglasung / Vitrage	122
Madlá a príslušenstvo / Handles and accessories / Griffe und Zubehör / Mains courantes et accessoires	126

SK	Označenie výplne	Strana
EN	Door panel label	Side
DE	Türfüllungs-Bezeichnung	Seite
FR	Désignation du panneau	Côté
	GAVA 010	48
	GAVA 011	48
	GAVA 012	48,50,51,52,53
	GAVA 012/2	48,50
	GAVA 015	48
	GAVA 020	49
	GAVA 021	49,51,52,53
	GAVA 021/2	49
	GAVA 025	49
	GAVA 025/2	49
	GAVA 030	54
	GAVA 031	54,56,57
	GAVA 031/2	56
	GAVA 032	55,56,57
	GAVA 032/2	55
	GAVA 032/2 extra	55
	GAVA 033	54,56,57
	GAVA 033/2	54,56
	GAVA 040	65
	GAVA 041	64,65
	GAVA 042	65
	GAVA 042/2	65
	GAVA 050	71
	GAVA 051	71
	GAVA 052	71
	GAVA 060	72
	GAVA 061	72
	GAVA 062	72
	GAVA 062/2	72
	GAVA 063	72
	GAVA 070	58
	GAVA 071	58
	GAVA 072	58
	GAVA 073	59
	GAVA 074	59
	GAVA 074/2	59
	GAVA 075	59
	GAVA 080	60
	GAVA 081	60
	GAVA 081/2	60

	GAVA 082	60
	GAVA 090	70
	GAVA 091	70
	GAVA 100	80
	GAVA 101	79,80,81
	GAVA 101/2	81
	GAVA 110	81
	GAVA 111	81
	GAVA 112	81
	GAVA 120	81
	GAVA 121	81
	GAVA 130	83
	GAVA 131	83
	GAVA 131/2	83
	GAVA 132	83
	GAVA 132/2	83
	GAVA 133	83
	GAVA 140	82
	GAVA 141	82
	GAVA 142	82
	GAVA 144	82
	GAVA 145	82
	GAVA 150	77
	GAVA 151	77,78
	GAVA 152	77
	GAVA 153	77
	GAVA 160	76
	GAVA 161	76
	GAVA 170	76
	GAVA 171	76
	GAVA 181	76
	GAVA 200	63
	GAVA 201	63
	GAVA 205	63
	GAVA 206	63
	GAVA 210	62
	GAVA 211	62
	GAVA 220	75
	GAVA 221	74,75
	GAVA 223	75
	GAVA 225	75
	GAVA 226	75
	GAVA 226/2	75
	GAVA 230	71

	GAVA 231	71
	GAVA 232	71
	GAVA 240	61
	GAVA 241	61
	GAVA 250	74
	GAVA 251	74
	GAVA 260	77
	GAVA 261	77
	GAVA 270	66
	GAVA 271	66,68
	GAVA 272	66,68
	GAVA 273	66
	GAVA 280	73
	GAVA 281	73
	GAVA 282	73
	GAVA 283	73
	GAVA 290	67
	GAVA 291	67,69
	GAVA 292	67,69
	GAVA 293	67
	GAVA 400	100
	GAVA 401	94
	GAVA 402	94
	GAVA 403	100
	GAVA 405	94
	GAVA 408	107
	GAVA 409	118
	GAVA 410	98
	GAVA 411	98
	GAVA 412	97
	GAVA 412b	97
	GAVA 413	95
	GAVA 413b	95
	GAVA 414	98
	GAVA 416a	103
	GAVA 416b	103
	GAVA 416c	103
	GAVA 417	92
	GAVA 418	99
	GAVA 419	99
	GAVA 422	107
	GAVA 423	107
	GAVA 424	107
	GAVA 426	109

	GAVA 427	109
	GAVA 428	108
	GAVA 429	108
	GAVA 430	120
	GAVA 431	120
	GAVA 433	121
	GAVA 435b	121
	GAVA 437a	119
	GAVA 437c	119
	GAVA 438a	119
	GAVA 441	110
	GAVA 442	108
	GAVA 443	111
	GAVA 444b	111
	GAVA 445	111
	GAVA 447	106
	GAVA 448	106
	GAVA 451	97
	GAVA 460	110
	GAVA 461	110
	GAVA 463a	110
	GAVA 464b	95
	GAVA 465	98
	GAVA 466	98
	GAVA 469	110
	GAVA 470a	101
	GAVA 470b	101
	GAVA 473	96
	GAVA 479	96
	GAVA 481	119
	GAVA 484a	119
	GAVA 486	115
	GAVA 487	115
	GAVA 488a	94
	GAVA 490	93
	GAVA 491	93
	GAVA 492	93
	GAVA 494	102
	GAVA 495	102
	GAVA 497	106
	GAVA 498	109
	GAVA 499	108
	GAVA 511	93
	GAVA 512	92

	GAVA 513	92
	GAVA 514	92
	GAVA 515	94
	GAVA 516	98
	GAVA 517	98
	GAVA 519	99
	GAVA 520	99
	GAVA 521	98
	GAVA 522	97
	GAVA 523	96
	GAVA 524	96
	GAVA 525	97
	GAVA 526	96
	GAVA 527	95
	GAVA 528	95
	GAVA 529	92
	GAVA 540	100
	GAVA 541	101
	GAVA 542	101
	GAVA 543	101
	GAVA 544	101
	GAVA 546	104
	GAVA 547	105
	GAVA 548	104
	GAVA 550	105
	GAVA 551a	105
	GAVA 551b	105
	GAVA 553	102
	GAVA 554	103
	GAVA 556	106
	GAVA 560	112
	GAVA 561a	112
	GAVA 561b	112
	GAVA 562	113
	GAVA 564a	114
	GAVA 564b	114
	GAVA 564c	114
	GAVA 564d	114
	GAVA 565a	114
	GAVA 565b	114
	GAVA 565c	114
	GAVA 565d	114
	GAVA 567	112
	GAVA 568	113

	GAVA 570	117
	GAVA 571	117
	GAVA 572	117
	GAVA 573	117
	GAVA 575	116
	GAVA 576	116
	GAVA 577	117
	GAVA 578a	117
	GAVA 578b	117
	GAVA 579	117
	GAVA 580	120
	GAVA 581	120
	GAVA 582	118
	GAVA 583	118
	GAVA 585	120
	GAVA 586	120
	GAVA 587	121
	GAVA 589	121
	GAVA 652	34
	GAVA 660	35
	GAVA 663	35
	GAVA 665	35
	GAVA 670	35
	GAVA 674	35
	GAVA 681	32
	GAVA 682	32
	GAVA 688	32
	GAVA 689	32
	GAVA 691	34
	GAVA 695	34
	GAVA 696	34
	GAVA 701	16,17
	GAVA 701/2	17
	GAVA 702	27
	GAVA 731	18
	GAVA 732	18
	GAVA 732/2	18
	GAVA 741	29
	GAVA 742	29
	GAVA 751	23
	GAVA 752	23
	GAVA 754	23
	GAVA 761	14
	GAVA 762	14

	GAVA 763	14
	GAVA 763/2	14
	GAVA 773	33
	GAVA 774	33
	GAVA 775	33
	GAVA 782	22
	GAVA 786	35
	GAVA 801	41
	GAVA 811	41
	GAVA 861	23
	GAVA 864	31
	GAVA 871	38
	GAVA 872	38
	GAVA 873	38
	GAVA 874	36
	GAVA 875	36,37
	GAVA 877	40
	GAVA 878	40
	GAVA 879	40
	GAVA 880	36
	GAVA 881	36
	GAVA 882	37
	GAVA 885	40
	GAVA 887	40
	GAVA 891	39
	GAVA 892	39
	GAVA 893	39
	GAVA 900	24
	GAVA 902	26
	GAVA 903	26
	GAVA 904	26
	GAVA 906	22
	GAVA 907	22
	GAVA 912	20
	GAVA 912/2	20,21
	GAVA 912a	20
	GAVA 913	21
	GAVA 913a	21
	GAVA 914	21
	GAVA 916	24
	GAVA 916/2	24
	GAVA 917	15
	GAVA 917/2	15
	GAVA 918	18

	GAVA 918a	18
	GAVA 919	15
	GAVA 919/2	15
	GAVA 926	28
	GAVA 927	28
	GAVA 928	29
	GAVA 929	28
	GAVA 929a	28
	GAVA 939	41
	GAVA 945	31
	GAVA 946	31
	GAVA 947	31
	GAVA 948	27
	GAVA 950	31
	GAVA 951	27
	GAVA 952	27
	GAVA 953	27
	GAVA 954	27
	GAVA 955	27
	GAVA 956	27
	GAVA 961	30
	GAVA 961/2	30
	GAVA 961a	30
	GAVA 962	30
	GAVA 963	30
	GAVA 964	16
	GAVA 964a	16
	GAVA 964a/2	16
	GAVA 964b	16
	GAVA 965	20
	GAVA 990	19
	GAVA 991	19
	GAVA 991/2	19
	GAVA 992	19
	GAVA 994	25
	GAVA 995	25
	GAVA 997	25



TREND:

Trendom súčasnosti i budúcnosti je znižovanie energetickej náročnosti budov. Preto sa kladie veľký dôraz aj na znižovanie prestupu tepla dverí U (W/m²K), čím sa dosahuje aj zväčšovanie rozdielov teplôt medzi exteriérovými a interiérovými povrchmi.

ZVÄČŠOVANIE HRÚBOK VÝPLŇÍ:

Prirodzené naplnenie požiadavky zlepšenia U sa rieši zväčšovaním hrúbok profilových systémov, počtu ich komôr, počtu vrstiev zasklení, redukovaním tepelných mostov atď... a následne aj zväčšením hrúbok dverných panelov.



TREND:

The trend is now and will in the future be toward reducing energy consumption in buildings. Therefore, a lot of emphasis is being placed on reducing a door's U-value (thermal transmittance in W/m²K), while raising the difference in temperature between its outdoor and indoor surfaces.

ENLARGING PANEL THICKNESS:

Requirements for an improved U-value are being met naturally with the profile system becoming thicker and a higher number of chambers and glass layers, while reducing thermal bridges, etc. and subsequently making the door panels thicker, too.



TREND:

Ein gegenwärtiger und zukünftiger Trend ist die Verringerung der Energieintensität von Gebäuden. Deshalb wird auch großer Wert auf die Verringerung der Wärmeübertragung U (W/m²K) bei Türen gelegt, wodurch auch eine Vergrößerung des Temperaturunterschieds zwischen Oberflächen innen und außen erreicht wird.

VERGRÖßERUNG DER TÜRFÜLLUNGSSTÄRKE:

Die Erfüllung der geforderten Verbesserung von U wird auf natürliche Weise durch Vergrößerung der Stärke der Profilsysteme, durch Erhöhung der Zahl ihrer Kammern und der Zahl der Glasschichten, durch Reduktion von Wärmebrücken usw. ... und nachfolgend auch durch Vergrößerung der Stärke der Türplatten erzielt.



TENDANCE:

La tendance actuelle et future est à la réduction de l'intensité énergétique des bâtiments. C'est pourquoi un grand accent est également mis sur la diminution du passage de la chaleur des portes U (W/m²K), ce qui entraîne aussi un accroissement des différences de températures entre les surfaces extérieures et intérieures.



AGRANDISSEMENT DES ÉPAISSEURS DES PANNEAUX:

L'accomplissement naturel des demandes d'amélioration du coefficient U est résolu en agrandissant les épaisseurs des systèmes de profilés, le nombre de leurs chambres, le nombre des couches de vitrage, en réduisant les ponts thermiques, etc... et, ultérieurement également en agrandissant les épaisseurs des panneaux de portes.

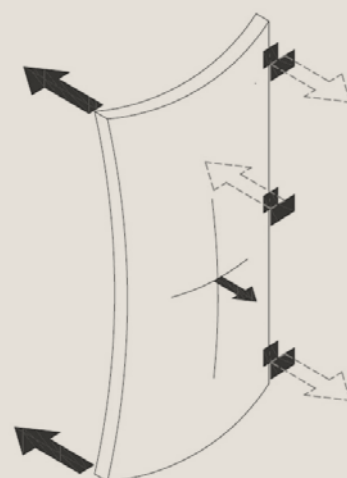

ZVÝŠENÁ TUHOŠŤ PANELA:

Zväčšenie rozdielu povrchových teplôt panela má za následok jeho vlastnú deformáciu = bi-metalový jav, ktorý samozrejme pôsobí aj na profily dverí.

Zväčšovaním hrúbky panela rastie jeho vlastná tuhosť. Tá sa následne prejavuje zväčšeným silovým pôsobením panela na krídlo.

PREKVAPENIE UŽÍVATEĽA:

Následkom zvýšeného silového pôsobenia je možná dodatočná deformácia dverného krídla, ktorá spôsobuje zvýšenie ovládacích síl a vznik netesnosti dverí. Potreba vyšších ovládacích síl je diskomfortná a netesnosti obvykle celkom degradujú snahu o zlepšenie teplototechniky.

GREATER PANEL RIGIDITY:

Raising the difference between panel surface temperatures causes panels to become deformed, a bimetallic phenomenon that of course affects door profiles.

Making panels thicker also makes them more rigid, which in turn translates into greater force acting on the leaf panel.

A SURPRISE FOR USERS:

When the force acting on a door rises, it results in additional deformation of the panel, increasing operating forces and causing door leakage. The need for higher actuating forces is discomforting and leaks usually degrade efforts altogether to improve heat transfer.

ERHÖHUNG DER PLATTENSTEIFIGHEIT:

Die Vergrößerung der Unterschiede zwischen den Oberflächentemperaturen der Platten hat deren Deformation zur Folge = ein Bimetal-Effekt, der natürlich auch auf die Türprofile wirkt.

Durch Vergrößerung der Stärke der Platten wächst auch deren Steifigkeit. Die manifestiert sich dann in einer größeren Kraftausübung der Platte auf den Türflügel.

ÜBERRASCHUNG DES BENUTZERS:

Folge der erhöhten Kräfteinwirkung kann eine nachträgliche Deformation des Türflügels sein, sodass die Türbedienung mehr Anstrengung erfordert und Undichtigkeiten an der Tür entstehen. Der zur Türbedienung notwendige größere Kraftaufwand ist unbequem, und Undichtigkeiten werden die Bemühungen um eine Verbesserung der Wärmetechnologie insgesamt ab.

RIGIDITE ACCRUE DU PANNEAU:

L'accroissement de la différence des températures superficielles du panneau a comme conséquence sa propre déformation = manifestation bimétallique, qui agit bien évidemment également sur les profilés de portes.

La rigidité propre du panneau grandit avec l'accroissement de son épaisseur. Cette rigidité se manifeste ensuite par une action accrue des forces du panneau sur le battant.

SURPRISE DE L'UTILISATEUR:

Une déformation complémentaire du battant de porte, entraînant un accroissement des forces de commande et la naissance de défauts d'étanchéité sur les portes, est possible en conséquence d'une action accrue des forces. La nécessité de forces de commande plus importantes est inconfortable et les défauts d'étanchéité mettent généralement à bas l'effort d'ensemble mis sur l'amélioration de la technique s'appliquant à la chaleur.

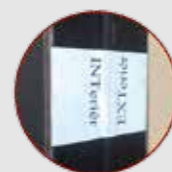

VÝVOJ:

Smerovaniu vývoja riešenia predchádzala analýza procesov v tepelne zaťažovanej sendvičovej konštrukcii. Jej záverom sú výpočtové metódy vyvinuté Drh.c. prof. Ing. Jánom Ravingerom, DrSc. Okrem toho sme absolvovali stovky hodín meraní silových účinkov panelov pri teplotných zaťaženiach na našom meracom zariadení.

Vďaka tomu môžeme vysloviť a preukázať tvrdenie, že nie absolútna veľkosť priehybu panela je určujúca, ale silové pôsobenie panela na krídlo.

RIEŠENIE = Jadro F:

Podstatou riešenia je výrazná redukcia síl prenášaných do krídla umožnením dilatácie exteriérovej strany a zároveň zachovanie dostatočnej tuhosti výplne.

ÚŽITKOVÝ VZOR:

Pre produkt Jadro F sme získali úžitkový vzor, čo tiež potvrdzuje originalitu a prínos tohto technického riešenia.

DEVELOPMENT:

Before a solution is developed, an analysis is conducted of the processes in a thermally-loaded sandwich structure, employing calculation methods that were developed by Drh.c. prof. Ing. Ján Ravinger, DrSc. In addition, hundreds of hours have been spent measuring with our own instruments how forces acting against the panels affect them at thermal loads.

This allows us to express and support our claim that it is not the absolute size of the panel deflection which is decisive, but the force of the panel acting on the leaf.

THE SOLUTION = F Core:

In essence, the solution is to significantly reduce forces transmitted to the leaf, allowing the outdoor side to dilate while the panel filling maintains sufficient rigidity.

REGISTERED DESIGN:

F Core's product design is patented, both confirming the originality of the design and illustrating the benefits of this technical solution.

ENTWICKLUNG:

Der Ausrichtung der Entwicklung neuer Lösungen ging eine Analyse der Prozesse in einer thermisch belasteten Sandwich-Konstruktion voraus. Deren Ergebnis sind von Drh.c. prof. Ing. Ján Ravinger, DrSc. entwickelte Berechnungsmethoden. Außerdem haben wir auf unserer Messtation über hunderte Stunden hinweg die Wirkung von Kräften an den Platten bei thermischer Belastung gemessen.

Dank dessen können wir die Behauptung aussprechen und auch beweisen, dass nicht die absolute Größe der Plattendurchbiegung entscheidend ist, sondern die Kraftausübung der Platten auf den Flügel.

LÖSUNG = Kern F:

Im Wesentlichen besteht die Lösung in einer deutlichen Reduktion der auf den Flügel übertragenen Kräfte durch Ermöglichung der Ausdehnung der Außenseite bei gleichzeitiger Aufrechterhaltung genügender Steifigkeit der Türfüllung.

GEBRUCHSMUSTER:

Für das Produkt Kern F haben wir ein Gebrauchsmuster erhalten, was ebenfalls die Originalität und die Vorteile dieser technischen Lösung bestätigt.

DEVELOPPEMENT:

Une analyse des processus dans une structure en sandwich soumise à une charge thermique a précédé l'orientation empruntée par le développement de la conception. Les méthodes de calcul développées par Drh.c. prof. Ing. Ján Ravinger, DrScn, en ont été le point culminant. En outre, nous avons procédé à des centaines d'heures de mesures des effets des forces des panneaux avec des charges thermiques sur notre équipement de mesure.

Grâce à cela, nous pouvons exprimer et démontrer l'affirmation selon laquelle ce n'est pas la taille absolue de déformation du panneau qui est déterminante, mais bien l'action des forces du panneau sur le battant.

SOLUTION = Noyau F:

Le fond de la conception est une réduction considérable des forces transmises dans le battant en permettant une dilatation de la face externe, tout en gardant une rigidité suffisante du panneau.

ECHANTILLON UTILITAIRE:

Nous avons obtenu un échantillon utilitaire pour le produit Noyau F, ce qui confirme également l'originalité et l'apport de cette solution technique.

GAVA hpl



Drážka pre intarziu / Groove for Inlay /
Nut für Intarsien/ Rainure pour intarsia



Lepenie intarzie / Gluing up Inlay /
Kleben von Intarsien / Collage de l'intarsia



10
Intarzia / Inlay / Intarsie / Incrustation



8
Applikácia / Application / Applikation / Application



GAVA 775 sklo matelux / GAVA 775 matelux glass /
GAVA 775 Matelux-Glas / GAVA 775 verre matelux



15
Madlo v ploche výplne / Panel surface handle / Griff in
Füllungsfläche/ Main courante dans la surface du panneau



HPL nie je možné tepelne tvarovať, preto je používaný pre výrobu plochých dizajnov. Tie sú tvorené kombináciou presklených plôch a kovových aplikácií či intarzií. Všetky dizajny sa dodávajú v širokej škále farebných odtieňov.



HPL cannot be thermoformed and so are used for producing flat designs. These are formed with a combination of glass surfaces and metal applications or inlays. All designs are available in a broad range of different hues.



HPL (High Pressure Laminates) je materiál na živicovej báze vystužený celulóзовými vláknami, vyrábaný pri vysokých tlakoch a teplotách. Je tvrdší a má menšiu teplotnú rozťažnosť ako PVC a hliník, ale na rozdiel od nich je čiastočne hydrofóbny. Pri použití hrúbok od 36mm odporúčame použiť Jadro F pre výraznú redukciu nepriaznivých síl pôsobiacich na dvere pri celoročne rozdielnych klimatických podmienkach v exteriéri.



HPL (High Pressure Laminates) are a resin-based material reinforced with cellulose fibers that are manufactured under high pressure and at high temperatures. Harder and with a lower thermal expansion than PVC and aluminum, in contrast to them it is partially hydrophobic. When thickness is greater than 36 millimeters, Core F is recommended to significantly reduce the adverse forces acting under different climatic conditions on the door all year round.



HPL kann nicht warm umgeformt werden, weshalb es bei der Herstellung von flachen Designs verwendet wird. Diese werden aus einer Kombination von Glasflächen und Metallapplikationen oder Intarsien geschaffen. Alle Designs werden in einer breiten Farbtionskala geliefert.



Les HPL ne peuvent pas être façonnés thermiquement, ils sont donc utilisés pour la production de designs plats. Ceux-ci sont formés par une combinaison de surfaces vitrées et d'applications ou d'incrustations de métal. Tous les designs sont livrés dans une large gamme de teintes de couleurs.



HPL (High Pressure Laminates) ist ein Material auf Basis von mit Zellulosefasern verstärktem Harz, hergestellt bei hohen Drücken und Temperaturen. Es ist härter und hat eine geringere Wärmeausdehnung als PVC und Aluminium, ist im Unterschied zu diesen jedoch teilweise wasserabweisend. Bei Verwendung von Stärken ab 36 mm empfehlen wir die Verwendung von Kern F zur deutlichen Reduzierung ungünstiger, bei wechselnden klimatischen Außenbedingungen während des ganzen Jahres auf die Tür einwirkender Kräfte.



Les HPL (High Pressure Laminates) sont un matériau à base de bitume renforcé par des fibres de cellulose, produit à hautes pressions et températures. Il est plus dur et a une dilatation thermique moindre que le PVC et l'aluminium, mais, à la différence de ceux-ci, est partiellement hydrophobe. En cas d'utilisation d'épaisseurs à partir de 36 mm, nous recommandons d'utiliser un Noyau F pour une réduction considérable des forces défavorables agissant sur la porte du fait des conditions climatiques extérieures différentes au cours de l'année.

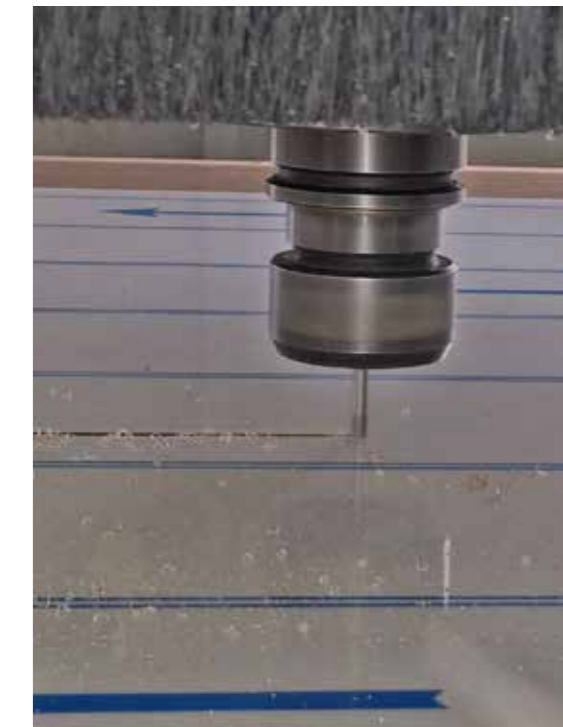

hpl
High Pressure Laminates

HPL							
typ jadra výplne panel core Kerntyp der Füllung type de noyau de panneau	hrúbka výplne panel thickness Stärke der Füllung épaisseur du panneau	max. rozmery max. dimensions Höchstabmessungen dimensions max.	teplo technika thermal technique Wärmetechnik technique de chaleur		počet tabulí izolačného zasklenia number of insulated glass panels Zahl der Isolierglasscheiben nombre de plaques de vitrage d'isolation	akustika acoustics Akustik acoustique	
			U (W/m²K)	R (m²K/W)			(ks / piece / Stück / pièce)
XPS	24, 36, 40, 44	900 x 2150	1.1	0.91	2	●○○○○	
			0.86	1.16	3	●○○○○	
			0.8	1.25	3	●○○○○	
			0.73	1.36	3	●○○○○	
	+ Ocel. Platňa + steel plate + Stahleinlage + plaque en acier	24, 36, 40, 44	900 x 2150	1.17	0.86	2	●●●○○
				0.93	1.07	3	●●●○○
				0.84	1.19	3	●●●○○
				0.76	1.31	3	●●●○○
Jadro F	24, 36, 40, 44, > 48	900 x 2150	-	-	-	-	
			0.9	1.11	3	●●○○○	
			0.82	1.22	3	●●○○○	
			0.74	1.34	3	●●○○○	
			< 0.68	1.46	3	●●○○○	
	+ Ocel. Platňa + steel plate + Stahleinlage + plaque en acier	24, 36, 40, 44, > 48	900 x 2150	-	-	-	-
				0.91	1.1	3	●●●○○
				0.82	1.22	3	●●●○○
				0.75	1.34	3	●●●○○
				< 0.69	1.46	3	●●●○○

bezpečnosť security Sicherheit sécurité	hmotnosť weight Gewicht poids	vodorovné sily - pôsobenie na krídlo horizontal forces - acting on the leaf Horizontalkräfte - Einwirkung auf den Flügel forces horizontales - action sur le battant	tesnosť dverí door tightness Dichtheit der Tür étanchéité de de la porte	potenciál komfortu ovládania dverí potenzieller Bedienkomfort der Tür potentiel de confort de commande de la porte	spojenie výplne s krídlom link to leaf panel Verbindung von Füllung und Flügel jonction du panneau et du battant			možnosť umiestniť madlo v ploche výplne ability to place a handle on the panel surface Möglichkeit der Griff- funterbringung in der Füllungsfläche possibilité de placer une main courante dans la surface du panneau
					vložená/embedded/eingelegt/inséré	eFD	bFD	
●●○○○○	▲	→→→→→	●●●○○	●●●○○	✓	-	-	-
●●○○○○	▲▲	→→→→→	●●●○○	●●●○○	✓	-	-	✓
●●○○○○	▲▲	→→→→→	●●●○○	●●●○○	✓	-	-	✓
●●○○○○	▲▲	→→→→→	●●●○○	●●●○○	✓	-	-	✓
●●●○○○	▲▲▲	→→→→→	●●●○○	●●●○○	✓	-	-	-
●●●○○○	▲▲▲▲	→→→→→	●●●○○	●●●○○	✓	-	-	✓
●●●○○○	▲▲▲▲	→→→→→	●●●○○	●●●○○	✓	-	-	✓
●●●○○○	▲▲▲▲	→→→→→	●●●○○	●●●○○	✓	-	-	✓
-	-	-	-	-	-	-	-	-
●●●○○○	▲▲	→→→	●●●●●	●●●●●	✓	-	-	✓
●●●○○○	▲▲	→→→	●●●●●	●●●●●	✓	-	-	✓
●●●○○○	▲▲	→→→	●●●●●	●●●●●	✓	-	-	✓
●●●○○○	▲▲	→→→	●●●●●	●●●●●	✓	-	-	✓
-	-	-	-	-	-	-	-	-
●●●●○○	▲▲▲▲	→→→	●●●●●	●●●●○	✓	-	-	✓
●●●●○○	▲▲▲▲	→→→	●●●●●	●●●●○	✓	-	-	✓
●●●●○○	▲▲▲▲	→→→	●●●●●	●●●●○	✓	-	-	✓
●●●●○○	▲▲▲▲	→→→	●●●●●	●●●●○	✓	-	-	✓

Farebné dekory / Colour designs / Farbdekore / Décors de couleur

Reprodukcia farieb je len približná / Colour rendering is only approximate / Die Farbwiedergabe ist nur annähernd / La reproduction des couleurs n'est qu'approximative



Anthrazitgrau
Renolit 7016 05-167



Anthrazit smooth
Hornschuch 436 7003



Metbrush Anthrazit
Hornschuch 436 1006



Earl Platin
Renolit 9.1293 010-119500



Crown Platin
Renolit 9.1293 001-119500



Basaltgrau
Hornschuch 436 7048



Qaurz Platin
Renolit 9.1293 002-119500

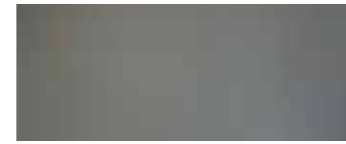

Titanium
Hornschuch 436 7049



Metbrush Silver
Hornschuch 436 1002



Grau
Renolit 7155 05-167



Metbrush AL
Hornschuch 436 1001



Signalgrau
Renolit 7004 05-083



Grau Smooth
Renolit 7155 05-083



Lichtgrau
Renolit 725105-167



Stahlblau
Renolit 5150 05-167



Briliantblau
Renolit 5007 05-167



Dunkelrot
Renolit 308105-167



Weinrot
Renolit 3005 05-167



Dark Green
Renolit 6125 05-167



Schwarzbraun
Renolit 8518 05-167



HPL Weiss

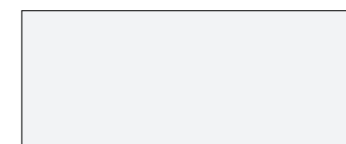

HPL Salamander

Drevodekory / Wood designs / Holzdekor / Décors bois



Palisander
Renolit 8875 05-167



Braun Maron
Renolit 8099 05-167



Eiche Dunkel
Renolit 2052 089



Mahagon
Renolit 2097 013



Mooreiche
Renolit 3167 004



Sapeli
Renolit 2065 021



Cherry Dunkel
Hornschuch 442 3070



Black Cherry
Renolit 3202 001-167



Eiche Rustikal
Renolit 3149 008



Nussbaum
Renolit 2178 007



Siena Noce
Renolit 49237-148



Tabasco
Renolit 2222 004-195



Siena Rosso
Renolit 49233-148



Staufereiche terra
Hornschuch 436 2035



Eiche Jalt
Renolit 3156 003-167



Macoré
Renolit 3162 002



Soft Cherry
Renolit 3214 009-195



Walnuss Kolonial
Hornschuch 436 3062



Sherwood W
Renolit 49201-011



Cherry blossom
Renolit 3214 008-195



Cherry Amaretto
Hornschuch 436 3043



Walnuss Amaretto
Hornschuch 436 3058



Streifendouglas
Renolit 3152 009



Noce Sorrento Balsamico
Hornschuch 436 3042



Sherwood G
Renolit 49158-011



Winchester
Renolit 49240-148



Golden Oak (Zlatý dub)
Renolit 2178 001



Eiche Hell
Renolit 2052090



Noce Sorrento Natur
Hornschuch 436 3041



Rustic Cherry
Renolit 3214 007-195



Indian
Renolit 49198-011



Canadian
Renolit 49195-011



Bergkiefer
Renolit 3069 041-167



Oregon 3
Renolit 2115 008-167



Oregon 4
Renolit 1192 001-167



Irish Oak
Renolit 3211005-167



Eiche Natur
Renolit 3118 076-168



Birke Rose
Hornschuch 436 3031



Sheffield Oak
Hornschuch 456 4081



Cremeweiss 1379
Renolit 116701-011



GAVA 763 763/2
8 8



GAVA 763
8 15



GAVA 917L
15



GAVA 917



GAVA 917L 917/2
15



GAVA 762L
8 15



GAVA 762L
8 15



GAVA 761
8



GAVA 919L
10 15



GAVA 919L 919/2
10 15 10



GAVA 919
10

hpl
High Pressure Laminates

8 Aplikácia
Application
Application
Application

10 Intarzia
Inlay
Intarsie
Incrustation

15 Madlo v ploche výplne
Panel surface handle
Griff in Füllungsfläche
Main courante dans la surface
du panneau

GAVA hpl



3 Vinvi detail

hpl
High Pressure Laminates

1 Pieskované sklo
Sandblasted glass
Sandgestrahltes Glas
Verre dépoli

3 Vitráž DecorGlass
Décor Glass panes
Buntglasfenster DecorGlass
Vitrage DecorGlass

8 Aplikácia
Application
Applikation
Application



GAVA 964



GAVA 701
8 1 Regular INV



GAVA 701
8 3 Waia



GAVA 701
8 3 Theby



GAVA 701
8 3 Vinvi



GAVA 701
8



GAVA 701
8 1 Tape INV



GAVA 701
8 1 Tenin

1 Tenin



GAVA 964a 964a/2
8 8



GAVA 964b
8



GAVA 701
8 1 Trois 8 1 Trois



GAVA 701 701/2
8 1 P3 x12 8 1 P1 x12

GAVA hpl



GAVA 918



GAVA 731

8



GAVA 732

8

732/2

8



GAVA 991

8 15

991/2

8



GAVA 990

8 15



GAVA 918



GAVA 918a

8



GAVA 992

8 15



GAVA 991

8 15



GAVA 992

8

GAVA hpl

hpl
High Pressure Laminates

8 Aplikácia
Application
Applikation
Application

15 Madlo v ploche výplne
Panel surface handle
Griff in Füllungsfläche
Main courante dans la surface
du panneau



GAVA 912a
8 1 Lugna INV



GAVA 912
15 912/2



GAVA 912
1 Spiral INV 1 Spiral INV



GAVA 913aL
8 15



GAVA 913L
15 3 Waia



GAVA 913L
15 1 Fluctus



GAVA 914
10 15



GAVA 912a
8



GAVA 912
15 1 Squire



GAVA 912
15 3 Masam



GAVA 913L
1 Tira INV



GAVA 913L
15 912/2



GAVA 965
10 15



GAVA 965
10 15



hpl
High Pressure Laminates

- 1 Pieskové sklo
Sandblasted glass
Sandgestrahltes Glas
Verre dépoli
- 3 Vitráž DecorGlass
Décor Glass panes
Buntglasfenster DecorGlass
Vitrage DecorGlass
- 8 Aplikácia
Application
Applikation
Application
- 10 Intarzia
Inlay
Intarsie
Incrustation
- 15 Madlo v ploche výplne
Panel surface handle
Griff in Füllungsfläche
Main courante dans la surface
du panneau

GAVA hpl



GAVA 906
10 15



GAVA 907
10 15



GAVA 782
8 15



GAVA 782
8 15



GAVA 906
10 15 1 Estala INV



GAVA 752
8



GAVA 751
8



GAVA 754
8 15 1 Sphere INV



GAVA 754
8 1 Versi



GAVA 754
8



GAVA 861L
8



GAVA 754
8 15 3 Entity



hpl
High Pressure Laminates

- 1 Pieskované sklo
Sandblasted glass
Sandgestrahltes Glas
Verre dépoli
- 3 Vitráž DecorGlass
Décor Glass panes
Buntglasfenster DecorGlass
Vitrage DecorGlass
- 8 Aplikácia
Application
Applikation
Application
- 10 Intarzia
Inlay
Intarsie
Incrustation
- 15 Madlo v ploche výplne
Panel surface handle
Griff in Füllungsfläche
Main courante dans la surface
du panneau

GAVA hpl

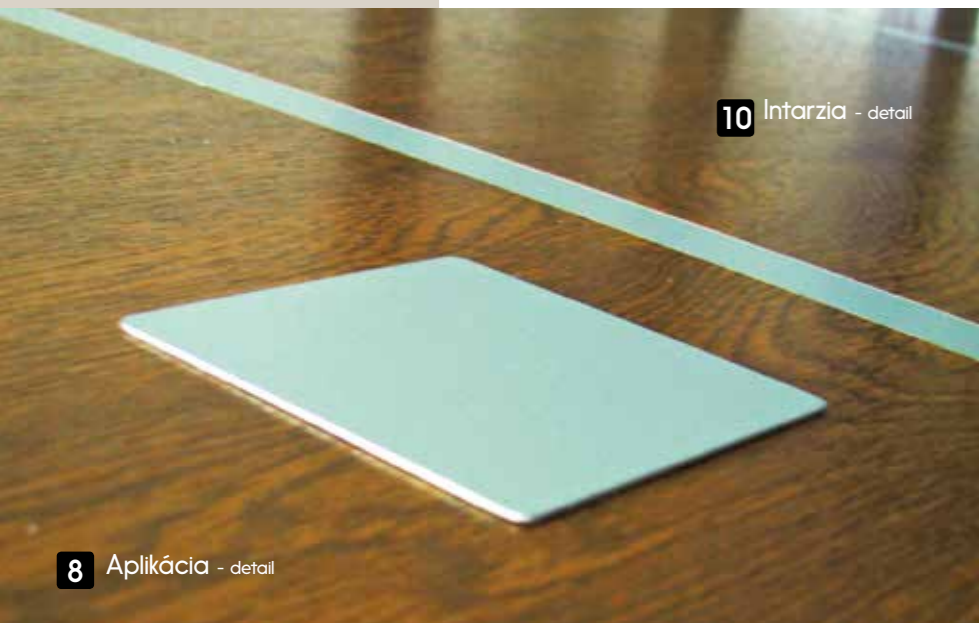

10 Intarzia - detail

8 Aplikácia - detail



GAVA 916



GAVA 916

916/2



GAVA 995

8



GAVA 995

8

1 P60 INV



GAVA 994

8



GAVA 900L

8 10 15



GAVA 916

15

916/2



GAVA 900

8 10



GAVA 997

8



GAVA 994

8



GAVA 997

8

hpl
High Pressure Laminates

1 Pieskované sklo
Sandblasted glass
Sandgestrahltes Glas
Verre dépoli

8 Aplikácia
Application
Applikation

10 Intarzia
Inlay
Intarsie
Incrustation

15 Madlo v ploche výplne
Panel surface handle
Griff in Füllungsfläche
Main courante dans la surface
du panneau

GAVA hpl



hpl
High Pressure Laminates

- 1** Pieskované sklo
Sandblasted glass
Sandgestrahltes Glas
Verre dépoli
- 8** Aplikácia
Application
Applikation
Application
- 10** Intarzia
Inlay
Intarsie
Incrustation
- 15** Madlo v ploche výplne
Panel surface handle
Griff in Füllungsfläche
Main courante dans la surface
du panneau



GAVA 902
10 15 **1** P18



GAVA 952L
10 15 **1** P60 INV



GAVA 948
10 15 **1** Fled



GAVA 702
8



GAVA 702
8



GAVA 955
8



GAVA 954L
10 15 **1** P18



GAVA 953
10



GAVA 903
10 15



GAVA 904
1 Trid **10** **1** Trid



GAVA 902
10 15



GAVA 951L
15



GAVA 956
8 **1** P60

GAVA hpl



hpl
High Pressure Laminates

- 1** Pieskované sklo
Sandblasted glass
Sandgestrahltes Glas
Verre dépoli
- 8** Aplikácia
Application
Applikation
Application
- 10** Intarzia
Inlay
Intarsie
Incrustation
- 15** Madlo v ploche výplne
Panel surface handle
Griff in Füllungsfläche
Main courante dans la surface
du panneau



GAVA 926
15



GAVA 926
1 Rettan INV **1** Rettan INV



GAVA 929a
8



GAVA 927
10 15



GAVA 927L
10 15 **1** P18



GAVA 929L
15



GAVA 929L



GAVA 742
8 **1** Damin



GAVA 928L
10 15 **1** P18



GAVA 741
8



GAVA 928L
10



GAVA 928L
10 15



GAVA hpl



GAVA 963
10 15



GAVA 962
10 15



GAVA 961
15



GAVA 947
10 1 Kiub INV



GAVA 864
8 15 1 Iras INV



GAVA 946L
10 15



GAVA 961a
8



GAVA 961 961/2



GAVA 950
8



GAVA 945
8 10



GAVA 946
10



GAVA 947L
10 15



hpl
High Pressure Laminates

- 1** Pieskované sklo
Sandblasted glass
Sandgestrahltes Glas
Verre dépoli
- 8** Aplikácia
Application
Applikation
Application
- 10** Intarzia
Inlay
Intarsie
Incrustation
- 15** Madlo v ploche výplne
Panel surface handle
Griff in Füllungsfläche
Main courante dans la surface
du panneau

GAVA hpl



hpl
High Pressure Laminates

- 1** Pieskované sklo
Sandblasted glass
Sandgestrahltes Glas
Verre dépoli
- 8** Aplikácia
Application
Applikation
- 10** Intarzia
Inlay
Intarsie
Incrustation
- 15** Madlo v ploche výplne
Panel surface handle
Griff in Füllungsfläche
Main courante dans la surface du panneau



GAVA 681
10 15



GAVA 681
10 15 1 Asil 1 P18



GAVA 688
10 15



GAVA 682
10 15 1 Myre



GAVA 682
10 15



GAVA 688
10 15



GAVA 689
10 15



GAVA 773
10 15



GAVA 775
8 10 15



GAVA 775
8 10 15

1 P18 INV



GAVA 773
10 15 1 Strimo



GAVA 774
8 10 15





GAVA 695
10 15 1 Nao



GAVA 696
10 15 1 Arami INV



GAVA 786
8 15



GAVA 665
10 15



GAVA 674
10 15



GAVA 660
10 15 1 Laryo



GAVA 691
8



GAVA 695L
10 15



GAVA 652
8



GAVA 691
8 3 Wave



GAVA 691L
8 3 Washington



GAVA 674
10 15 1 Ladri INV



GAVA 663
10 15 1 Laryo



GAVA 670
10 15 1 Laryo INV

hpl
High Pressure Laminates

- 1 Pieskované sklo
Sandblasted glass
Sandgestrahltes Glas
Verre dépoli
- 3 Vitráž DecorGlass
Décor Glass panes
Buntglasfenster DecorGlass
Vitrage DecorGlass
- 8 Aplikácia
Application
Applikation
Application
- 10 Intarzia
Inlay
Intarsie
Incrustation
- 15 Madlo v ploche výplne
Panel surface handle
Griff in Füllungsfläche
Main courante dans la surface
du panneau

GAVA hpl



hpl

High Pressure Laminates

- 1** Pieskované sklo
Sandblasted glass
Sandgestrahltes Glas
Verre dépoli
- 8** Aplikácia
Application
Applikation
Application
- 10** Intarzia
Inlay
Intarsie
Incrustation
- 15** Madlo v ploche výplne
Panel surface handle
Griff in Füllungsfläche
Main courante dans la surface
du panneau



GAVA 880
8 10 15



GAVA 874
8 15



GAVA 875
8 10 15



GAVA 875
8 10 15



GAVA 880
8 10 15



GAVA 881
8 15



GAVA 882
8 15

1 Tapa INV



GAVA 880
8 10 15

1 P18 INV



GAVA 881
8 15



GAVA 882
8 15

GAVA 882L
15 8

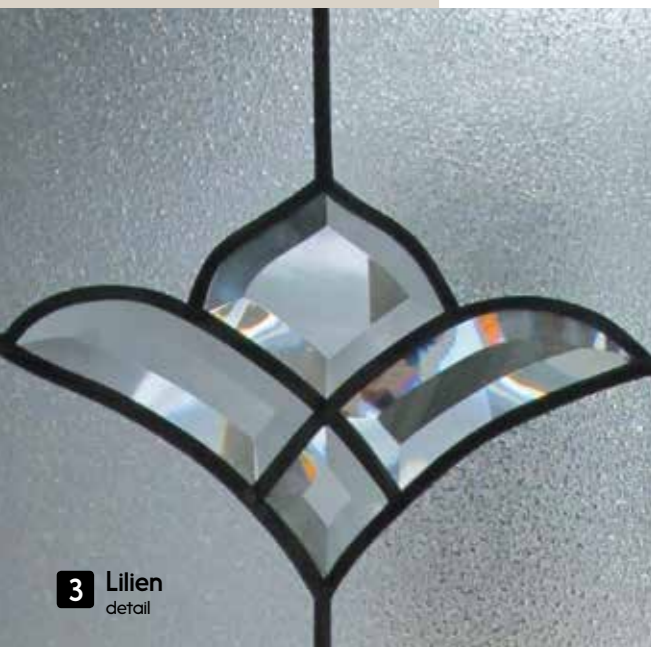

3 Lilien detail



GAVA 872
8 15 3 Lilien



GAVA 872
8 3 Luva



GAVA 873
8 15



GAVA 893
8



GAVA 892
8



GAVA 892
8



GAVA 891
8



GAVA 891
8 3 Linea



GAVA 892
8 3 Plane

GAVA hpl

hpl
High Pressure Laminates

1 Pieskované sklo
Sandblasted glass
Sandgestrahltes Glas
Verre dépoli

3 Vitráž DecorGlass
Décor Glass panes
Buntglasfenster DecorGlass
Vitrage DecorGlass

8 Aplikácia
Application
Applikation
Application

15 Madlo v ploche výplne
Panel surface handle
Griff in Füllungsfläche
Main courante dans la surface
du panneau



GAVA 871
8



GAVA 871
8 15 1 Aika



GAVA 871
8 15 1 Sipi

1 Sipi



GAVA 877
8 15



GAVA 878
8 15



GAVA 879
8 15



GAVA 801
8 15



GAVA 939
1 Midd INV



GAVA 939

1 Midd INV



GAVA 811
8 3 Game



GAVA 878
8 15



GAVA 885
8



GAVA 887
8 15



GAVA 885
8 1 P60



GAVA 811
8 15 1 Arcus

1 Arcus

hpl
High Pressure Laminates

- 1 Pieskované sklo
Sandblasted glass
Sandgestrahltes Glas
Verre dépoli
- 3 Vitráž DecorGlass
Décor Glass panes
Buntglasfenster DecorGlass
Vitrage DecorGlass
- 8 Aplikácia
Application
Applikation
Application
- 15 Madlo v ploche výplne
Panel surface handle
Griff in Füllungsfläche
Main courante dans la surface
du panneau

GAVA hpl

GAVA plast



3

Vitráž Symphony detail / Symphony panes detail /
Buntglasfenster Symphony Detail / Vitrage Symphony détail



3

Vitráž Fazeta detail / Fazeta panes detail /
Buntglasfenster Fazeta Detail / Vitrage Fazeta détail



3

Vitráž Entily detail / Entily panes detail /
Buntglasfenster Entily Detail / Vitrage Entily détail



GAVA 272 detail / GAVA 272 detail /
GAVA 272 Detail / GAVA 272 détail

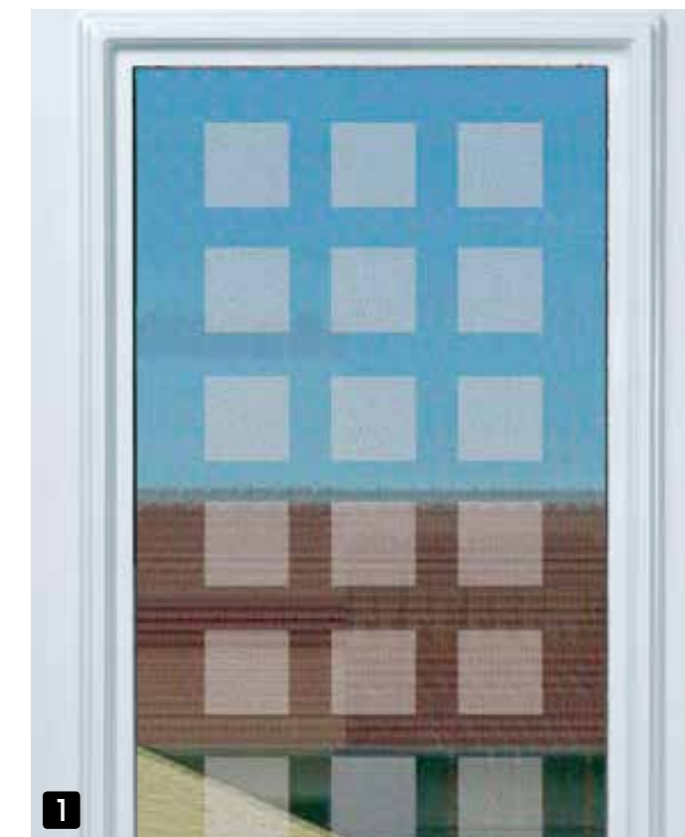

1

Pieskované štvorce detail / Sanded squares detail /
Sandgestrahlte Quadrate Detail / Carrés sablés détail



GAVA 040 detail / GAVA 040 detail /
GAVA 040 Detail / GAVA 040 détail



GAVA 141 detail / GAVA 141 detail /
GAVA 141 Detail / GAVA 141 détail

Drevodekory - imitácia dreva pre tvarované výplne / **Wood designs** - wood imitations for shaped panes
Holzdekor - Holzimitation für geformte Türfüllungen / **Décor bois** - imitation bois pour panneaux façonnés

Reprodukcia farieb je len približná / Colour rendering is only approximate / Die Farbwiedergabe ist nur annähernd / La reproduction des couleurs n'est qu'approximative



Anthrazitgrau
Renolit 7016 05-167



Moosgrün
6005 05-167



Quartzgrau
7039 05-167



Eiche Dunkel
Renolit 2052 089



Mahagon
Renolit 2097 013



Mooreiche
Renolit 3167 005



Sapeli
Renolit 2065 02



Cherry Dunkel
Hornschuch 442 3070



Eiche Rustikal
Renolit 3149 008



Nussbaum
Renolit 2178 007



Rosewood
Renolit 320 2002



Macoré
Renolit 3162 002



Cherry Amaretto
Hornschuch 436 3043



Streifendouglas
Renolit 3152 009



Noce Sorrento Balsamico
Hornschuch 436 3042



Golden Oak (Zlatý dub)
Renolit 2178 001



Cremeweiss
Renolit 1379 05-178



C156



C145

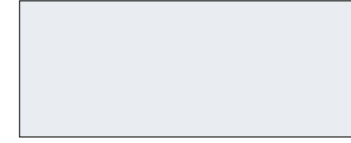

C152

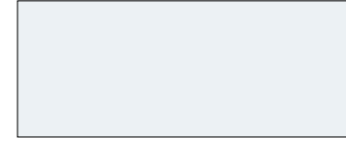

C160



C164



3 Symphony



3 Waia



2 Toera

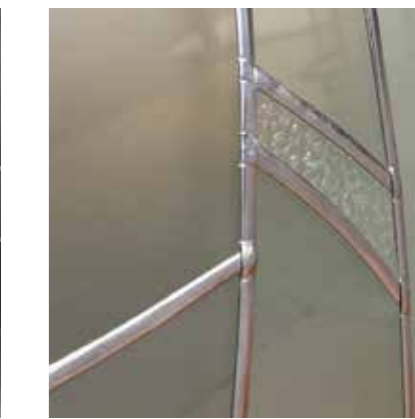

3 Trend

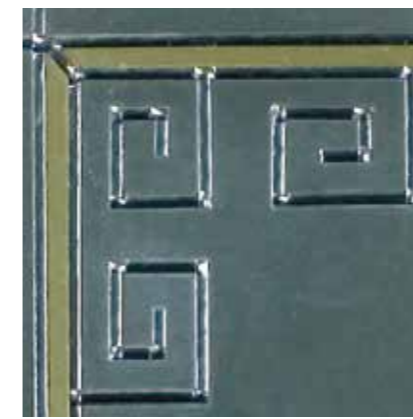

3 Theby

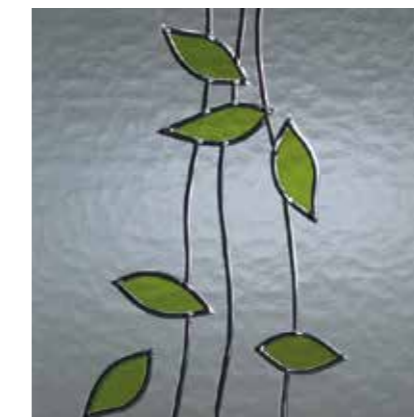

3 Leaves

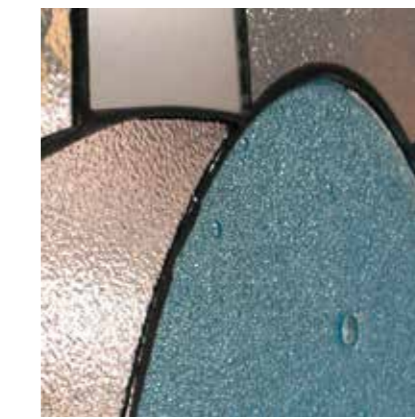

3 Pluto



2 Horizon

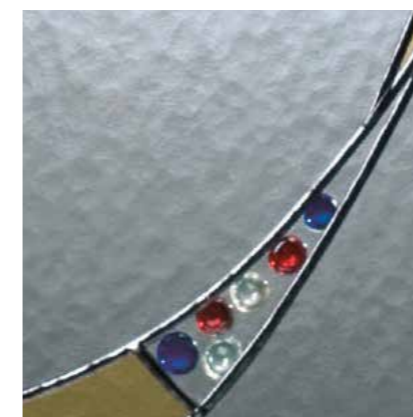

3 Figaro



3 Harmony

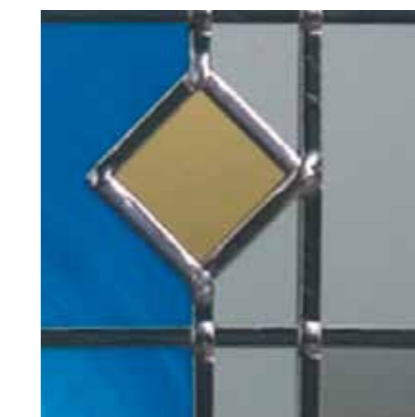

3 Forum

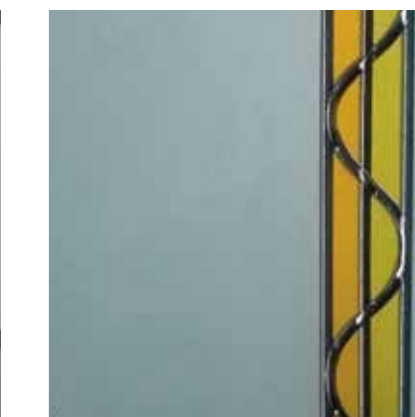

3 Sinus



3 Versa



3 Drinks



3 Flora



3 Metric



pvc

Polyvinylchlorid



GAVA 012

GAVA 012/2



GAVA 010



GAVA 015



GAVA 020



GAVA 025

GAVA 025/2



GAVA 021



GAVA 012

GAVA 012/2



GAVA 011



GAVA 021

GAVA 021/2



GAVA plast



2 Horizon detail



GAVA 012
2 Toera



GAVA 012
2 Abstrakt

GAVA 012/2
2 Abstrakt

GAVA 012
2 Horizon



GAVA 012
2 Kolibrík



GAVA 012
2 Twist



GAVA 012
2 Raute



GAVA 012
2 Kala



GAVA 012
2 Klasik



GAVA 012
2 Arkada



GAVA 021
2 Horizon



GAVA 021
2 Kala



GAVA 021
2 Motýle



2 Toera detail



GAVA 021
2 Toera

pvc

Polyvinylchlorid

2 Vitráž - Tiffany
Tiffany panes
Buntglasfenster - Tiffany
Vitrage - Tiffany

GAVA plast



GAVA 021
1 Espi



GAVA 021
1 O30 INV



GAVA 012
1 R20 INV



GAVA 021
1 001 INV



GAVA 012
1 012 INV



GAVA 012
1 Corola INV



GAVA 021
1 Specta INV



GAVA 012
1 Aces



GAVA 021
3 Tilia



GAVA 012
3 Tulip



GAVA 012
3 Waia blanc



GAVA 012
3 Fazeta



GAVA 021
3 Leaves



GAVA 021
3 Light Ray



pvc

Polyvinylchlorid

- 1 Pieskované sklo
Sandblasted glass
Sandgestrahtes Glas
Verre dépoli
- 3 Vitráž DecorGlass
Décor Glass panes
Buntglasfenster DecorGlass
Vitrage DecorGlass

GAVA plast



pvc

Polyvinylchlorid



GAVA 031



GAVA 031



GAVA 031



GAVA 032

GAVA 032/2 extra



GAVA 032



GAVA 033



GAVA 030



GAVA 033

GAVA 033/2



GAVA 030



GAVA 032



GAVA 032

GAVA 032/2



GAVA plast



pvc

Polyvinylchlorid

1 Pieskované sklo
Sandblasted glass
Sandgestrahtes Glas
Verre dépoli

3 Vitráž DecorGlass
Décor Glass panes
Buntglasfenster DecorGlass
Vitrage DecorGlass



GAVA 032
3 Pika



GAVA 032
3 Winta



GAVA 033
3 Rain



GAVA 032
1 Biro



GAVA 033
1 Grini INV



GAVA 032
1 PM8 INV



GAVA 031
1 PM15



GAVA 033
3 Pika



GAVA 032
3 Maroko



3 Maroko
detail



GAVA 033
3 Rose



GAVA 031
3 Maroko



GAVA 031/2
3 Maroko



GAVA 033
1 Rixa



GAVA 071



GAVA 070



GAVA 074

GAVA 074/2



GAVA 072



GAVA 071



GAVA 072



GAVA 073



GAVA 074



GAVA 075

pvc

Polyvinylchlorid

GAVA plast



GAVA 082



GAVA 080



GAVA 080



GAVA 241

3 Vinvi



GAVA 241

3 Flora



GAVA 241

3 Flora



GAVA 241



GAVA 081



GAVA 081

1 Tami INV

081/2

1 Tami INV

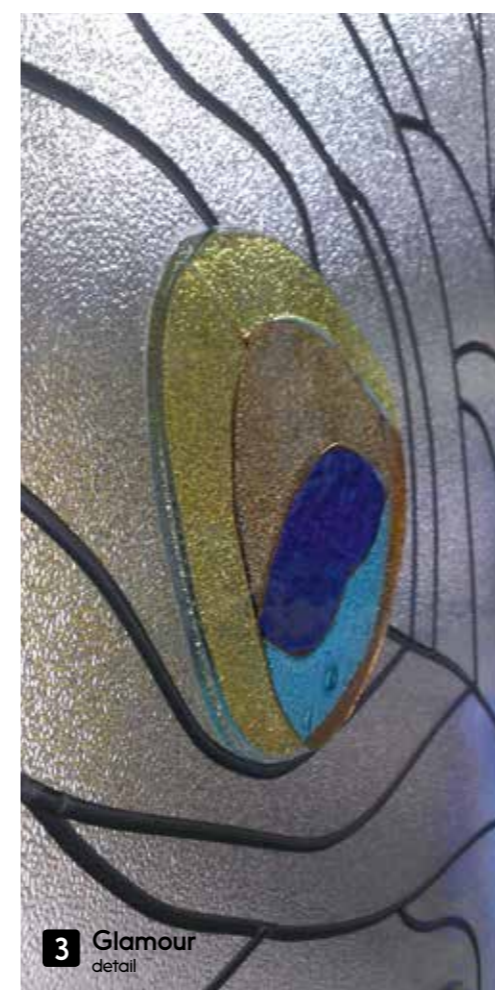

3 Glamour detail



GAVA 240



GAVA 241

3 Glamour



GAVA 241

3 Tide

pvc

Polyvinylchlorid

1 Pieskované sklo
Sandblasted glass
Sandgestrahltes Glas
Verre dépoli

3 Vitráž DecorGlass
Décor Glass panes
Buntglasfenster DecorGlass
Vitrage DecorGlass

GAVA plast



pvc

Polyvinylchlorid

- 1** Pieskované sklo
Sandblasted glass
Sandgestrahtes Glas
Verre dépoli
- 2** Vitráž - Tiffany
Tiffany panes
Buntglasfenster - Tiffany
Vitrage - Tiffany
- 3** Vitráž DecorGlass
Décor Glass panes
Buntglasfenster DecorGlass
Vitrage DecorGlass
- 15** Madlo v ploche výpne
Panel surface handle
Griff in Füllungsfläche
Main courante dans la surface
du panneau



GAVA 211



GAVA 211
2 Stone



GAVA 211
3 Game



GAVA 211
3 Figaro



GAVA 210
15



GAVA 211L
15

GAVA 211
15



GAVA 201
1 O20 INV



GAVA 206
1 Nivo



GAVA 206
15 1 Zirue INV



2 Stone
detail



GAVA 205



GAVA 200

GAVA plast



3 Versa detail



GAVA 041
1 Remas INV 1 Remas INV



GAVA 041
1 O20 INV



GAVA 041
1 Venera INV



GAVA 042



GAVA 042
3 Symphony



GAVA 042 GAVA 042/2



GAVA 041
3 Symphony



GAVA 041



GAVA 041
3 Waia blanc



GAVA 041
3 Laura



GAVA 041
3 Leaves



GAVA 041
3 Versa



GAVA 040



GAVA 041

pvc

Polyvinylchlorid

1 Pieskované sklo
Sandblasted glass
Sandgestrahtes Glas
Verre dépoli

3 Vitráž DecorGlass
Décor Glass panes
Buntglasfenster DecorGlass
Vitrage DecorGlass

GAVA plast



GAVA 270



GAVA 272



GAVA 272



GAVA 271



GAVA 271



GAVA 273



GAVA 290



GAVA 293



GAVA 291



GAVA 291



GAVA 292



GAVA 292



pvc

Polyvinylchlorid

15 Madlo v ploche výpne
Panel surface handle
Griff in Füllungsfläche
Main courante dans la surface
du panneau

GAVA plast



3 Variety detail

pvc

Polyvinylchlorid

1 Pieskované sklo
Sandblasted glass
Sandgestrahtes Glas
Verre dépoli

3 Vitráž DecorGlass
Décor Glass panes
Buntglasfenster DecorGlass
Vitrage DecorGlass

15 Madlo v ploche výplne
Panel surface handle
Griff in Füllungsfläche
Main courante dans la surface
du panneau



GAVA 272
1 Matao



GAVA 271
15 1 Turi INV 1 Turi INV



GAVA 271
1 Aika 1 Aika



GAVA 272
3 Metric



GAVA 272
3 Flower



GAVA 272
3 Lilien



GAVA 272
3 Glamour



GAVA 272
3 Luva



GAVA 292
3 Linea



GAVA 292
3 Variety



GAVA 292
1 Dori INV



GAVA 291
3 Trend



GAVA 292
1 Tribe INV



GAVA 292
3 Plane

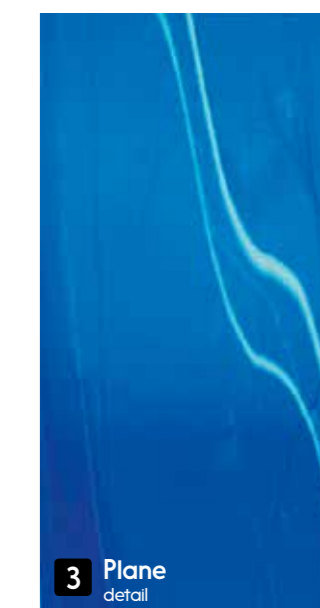

3 Plane detail



3 Trend detail

GAVA plast



GAVA 091
3 Wave



GAVA 091
3 Sinus



GAVA 091



GAVA 050



GAVA 051



GAVA 052



GAVA 091
3 Washington



GAVA 090



GAVA 052
3 Forum



GAVA 052



GAVA 230
15



GAVA 231



GAVA 232

pvc

Polyvinylchlorid

3 Vitráž DecorGlass
Décor Glass panes
Buntglasfenster DecorGlass
Vitrage DecorGlass

15 Madlo v ploche výplne
Panel surface handle
Griff in Füllungsfläche
Main courante dans la surface
du panneau

GAVA plast



3 Imari detail

pvc

Polyvinylchlorid

1 Pieskované sklo
Sandblasted glass
Sandgestrahtes Glas
Verre dépoli

3 Vitráž DecorGlass
Décor Glass panes
Buntglasfenster DecorGlass
Vitrage DecorGlass



GAVA 062

3 Imari



GAVA 062



GAVA 061



GAVA 282



GAVA 283



GAVA 063

1 O20 INV



GAVA 063



GAVA 283



GAVA 062

3 Polár

GAVA 062/2

3 Polár



GAVA 060



GAVA 281



GAVA 280



GAVA plast



2 Diami detail

pvc

Polyvinylchlorid

2 Vitráž - Tiffany
Tiffany panes
Buntglasfenster - Tiffany
Vitrage - Tiffany

3 Vitráž DecorGlass
Décor Glass panes
Buntglasfenster DecorGlass
Vitrage DecorGlass



GAVA 221

3 Gardi



GAVA 221

3 Gardi simple



GAVA 221

2 Pluto



GAVA 221

2 Diami



GAVA 226

GAVA 226/2



GAVA 223



GAVA 225



GAVA 221

3 Leaves



GAVA 221

3 Flora



GAVA 221



GAVA 250



GAVA 251

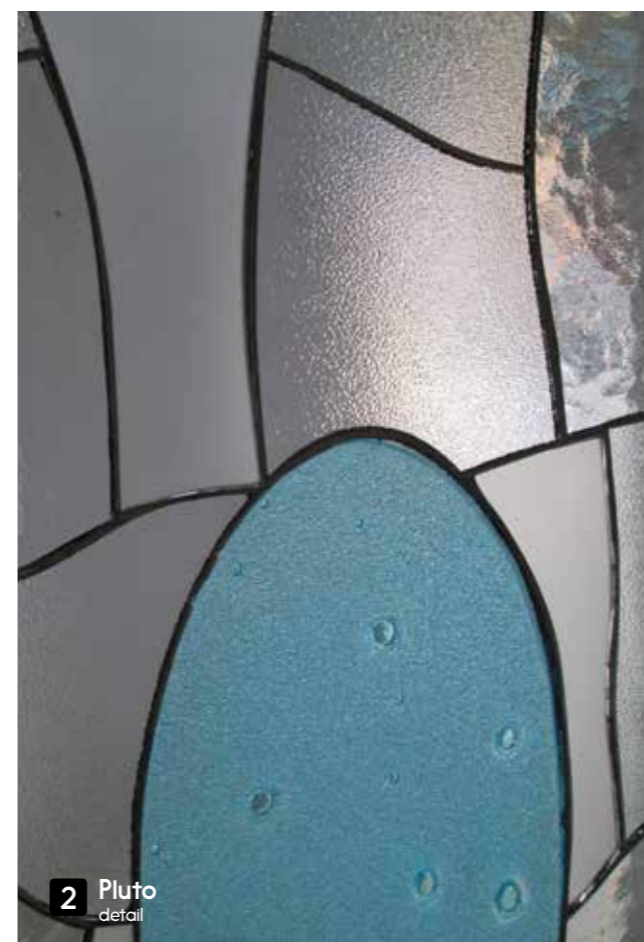

2 Pluto detail



GAVA 220

GAVA plast



pvc

Polyvinylchlorid

1 Pieskované sklo
Sandblasted glass
Sandgestrahtes Glas
Verre dépoli



GAVA 171



GAVA 150



GAVA 151



GAVA 151
1 Quadrat



GAVA 151
1 Selve INV



GAVA 152



GAVA 153



GAVA 151
1 P1x12 INV



GAVA 181



GAVA 161



GAVA 160



GAVA 170



GAVA 260



GAVA 261
1 Iras INV

GAVA plast



3 Masam detail

pvc
Polyvinylchlorid

3 Vitráž DecorGlass
Décor Glass panes
Buntglasfenster DecorGlass
Vitrage DecorGlass



3 Auri detail



GAVA 151
3 Brilliance



GAVA 151
3 Entily



GAVA 101
3 Theby



GAVA 101
3 Vinvi



GAVA 101
3 Glamour



GAVA 101
3 Light Ray



GAVA 101
3 Progres



GAVA 151
3 Drinks



GAVA 151
3 Masam



GAVA 101
3 Future



3 Vinvi detail



GAVA 101
3 Waia



GAVA 151
3 Array



GAVA 151
3 Harmony



GAVA 151
3 Auri

GAVA plast



GAVA 100



GAVA 100

1 Numero 123 INV



GAVA 112



GAVA 111



GAVA 110

pvc

Polyvinylchlorid

1 Pieskované sklo
Sandblasted glass
Sandgestrahtes Glas
Verre dépoli



GAVA 101

1 Sima INV



GAVA 101



GAVA 101

1 Offi INV



GAVA 101

1 Aris INV



GAVA 101

1 Cosmos



GAVA 101

1 P3x12

GAVA 101/2

1 P1x12



GAVA 120



GAVA 121

GAVA plast



pvc

Polyvinylchlorid

1 Pieskované sklo
Sandblasted glass
Sandgestrahtes Glas
Verre dépoli



GAVA 142



GAVA 142



GAVA 144



GAVA 131

GAVA 131/2



GAVA 131



GAVA 145



GAVA 141



GAVA 132

GAVA 132/2



GAVA 140



GAVA 130

1 Numero 143/2 INV



GAVA 132



GAVA 133L

GAVA plast

GAVA aluminium



12

Reliéfný profil / Relief profile / Reliefprofil / Profilé à relief



11

Drážka / Groove / Nut / Rainure



13

Týčový profil / Bar profile / Stangenprofil / Profilé linéaire



14

Gravír / Engraving / Gravur / Gravure



10 15

Intarzia štandard + madlo v ploche / Inlay Standard + Panel surface handle / Standard-Intarsien + Griff in Füllungsfläche / Incrustation standard + main courante dans la surface

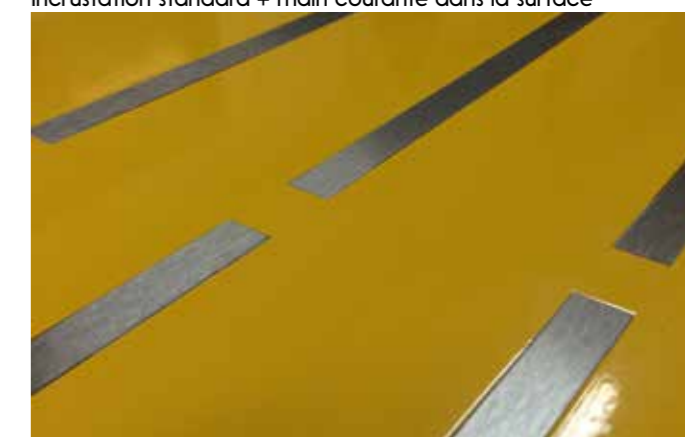

Intarzia 90° atyp / Inlay 90° atyp
Intarsie 90° atyp / Incrustation 90° atyp



Dizajn charakterizuje prepracovaná jednoduchosť, čistota v tvaroch a liniách. Výtvarné motívy môžu byť tvorené plnými a presklenými plochami, reliéfnymi alebo plochými tyčovými profilmi, frézovanými drážkami, nerezovými aplikáciami či intarziami. Klenotom vo dverách sú výplne vyrobené gravírovaním farebných plôch.

Hliníkové dverné výplne sú vďaka opísaným vlastnostiam a možnosti vyhotovenia aj v prevedení FD (flügeldeckende) t.j. krídlo prekrývajúcom dizajne. Ideálnym produktom pre náročných zákazníkov.



Das Design besticht durch vollendete Einfachheit, klare Formen und Linien. Kunstmotive können durch ausgefüllte und verglaste Flächen, durch Relief- oder flache Stangenprofile, gefräste Rillen, Edelstahlteile oder Intarsien geschaffen werden. Ein wahres Juwel in der Tür stellt eine Füllung aus gravierten Farbflächen dar.

Aluminiumtürfüllungen werden dank der beschriebenen Eigenschaften und Möglichkeiten auch in HD-Ausführung gefertigt, d. h., mit flügeldeckendem Design, einem idealen Produkt für anspruchsvolle Kunden.



The design is characterized by sophisticated simplicity and purity in shapes and lines. Creative motifs can be formed with solid or glass surfaces, relief or flat-bar profiles, milled grooves, stainless steel applications or inlays. The engraved color surfaces are encrusted with jewels set in the door.

The aluminum door fitting properties described earlier provide options for an overlapping door-leaf design - FD, while being the ideal product for demanding customers.



Le design est caractérisé par une simplicité travaillée, une pureté dans les formes et les lignes. Les motifs artistiques peuvent être formés par des surfaces pleines et vitrées, des sections à reliefs ou linéaires plates, des rainures fraisées, des applications d'inox ou des incrustations. Les panneaux fabriqués par gravure de surfaces colorées forment un bijou dans les portes.

Les panneaux de portes aluminium sont, du fait des propriétés décrites et de la possibilité d'une réalisation également dans une version FD (flügeldeckende), à savoir recouvrant le battant au niveau du design, un produit idéal pour les clients exigeants.



V dverných výplňach GAVA Aluminium sú použité kovové povrchové dosky zo zlatiny hliníku a horčíku. Vyznačujú sa vysokou pevnosťou a neprebíhajú v nich zmeny vnútorných napätí ani po dlhom čase. Na povrchy je nanesená farba technológiou práškového lakovania a následného vypálenia v peci.

Výplne GAVA Aluminium sa vyznačujú presnosťou opracovania na najmodernejších technológiách – rezanie laserom, CNC frézovanie a zváranie rámkov vyrábaných z nášho originálneho reliéfného profilu.

Pre vsadené výplne od hrúbky 36mm odporúčame použiť Jadro F pre výraznú redukciu nepriaznivých síl pôsobiach na dvere pri celoročne rozdielnych klimatických podmienkach v exteriéri.



In Türfüllungen GAVA Aluminium werden Metall-Deckplatten aus einer Aluminium-Magnesium-Legierung verwendet. Sie zeichnen sich durch hohe Festigkeit aus, wobei es in ihrem Inneren auch nach langer Zeit zu keiner Veränderung der Innenspannung kommt. Auf die Oberfläche wird Farbe mittels der Technologie Pulverlackierung aufgebracht und anschließend im Ofen gebrannt.

Füllungen GAVA Aluminium zeichnen sich durch genaue Verarbeitung mit modernster Technik aus – Schneiden mit Laser, CNC-Fräsen und geschweißte, aus unseren originellen Reliefprofilen hergestellte, Rahmen.

Für eingesetzte Füllungen ab einer Stärke von 36 mm empfehlen wir die Verwendung von Kern F zur deutlichen Reduzierung ungünstiger Kräfte, die über das ganze Jahr hinweg aufgrund wechselnder klimatischer Außenbedingungen auf die Tür einwirken.



GAVA Aluminum Door Panels use a metal surface plate made of aluminum and magnesium alloys. They are distinguished by their high strength, with no change in internal stress even over a long period of time. Color is applied to surfaces by powder varnishing before the lacquer is cured in an oven.

GAVA Aluminum Panels are noted for their precision machining, using the latest, cutting-edge technologies such as laser cutting, CNC milling and welded frames produced from our original relief profile.

When thickness is greater than 36 millimeters, Core F is recommended to significantly reduce the adverse forces acting under different climatic conditions on the door all year round.



Dans les panneaux de portes GAVA Aluminium sont utilisés des panneaux superficiels métalliques avec un alliage d'aluminium et de magnésium. Ils se caractérisent par une haute résistance et les transformations des tensions internes ne s'y déroulent pas, ni même après une longue période. Sur les surfaces est appliquée une peinture par une technologie de peinture en poudre et de cuisson ultérieure au four.

Les panneaux GAVA Aluminium se distinguent par la précision de finition sur les technologies les plus modernes - découpe au laser, fraisage CNC et soudure des cadres fabriqués à partir de notre profilé original à relief.

En cas d'installation d'un panneau d'une épaisseur à partir de 36 mm, nous recommandons d'utiliser un Noyau F pour une réduction considérable des forces défavorables agissant sur la porte du fait des conditions climatiques extérieures différentes au cours de l'année.



AI
Aluminium

AL													
typ jadra výplne panel core Kerntyp der Füllung type de noyau de panneau	hrúbka výplne panel thickness Stärke der Füllung épaisseur du panneau	max. rozmery max. dimensions Höchstabmessungen dimensions max.	teplo technika thermal technique Wärmetechnik technique de chaleur		počet tabulí izolačného zasklenia number of insulated glass panels Zahl der Isolierglasscheiben nombre de plaques de vitrage d'isolation	akustika acoustics Akustik acoustique							
			U (W/m²K)	R (m²K/W)			(ks / piece / Stück / pièce)						
XPS	24, 36, 40, 44	1150 x 2300	1.06	0.95	2	●●○○○	-	-	-	-	-	-	
			0.9	1.11	3	●●○○○							
			0.81	1.23	3	●●○○○							
			0.74	1.35	3	●●○○○							
	+ Ocel. Platňa + steel plate + Stahleinlage + plaque en acier	24, 36, 40, 44	1150 x 2300	1.14	0.87	2	●●●●○	-	-	-	-	-	-
				0.95	1.05	3	●●●●○						
				0.85	1.17	3	●●●●○						
				0.78	1.29	3	●●●●○						
Jadro F	24, 36, 40, 44, > 48	1150 x 2300	-	-	-	-	-	-	-	-	-	-	
			0.94	1.06	3	●●●○○							
			0.86	1.17	3	●●●○○							
			0.78	1.28	3	●●●○○							
			< 0.72	> 1.4	3	●●●○○							
	+ Ocel. Platňa + steel plate + Stahleinlage + plaque en acier	24, 36, 40, 44, > 48	1150 x 2300	-	-	-	-	-	-	-	-	-	-
				0.95	1.05	3	●●●●○						
				0.86	1.17	3	●●●●○						
				0.78	1.28	3	●●●●○						
				< 0.72	> 1.39	3	●●●●○						

bezpečnosť security Sicherheit sécurité	hmotnosť weight Gewicht poids	vodorovné sily - pôsobenie na krídlo horizontal forces - acting on the leaf Horizontalkräfte - Einwirkung auf den Flügel forces horizontales - action sur le battant	tesnosť dverí door tightness Dichtheit der Tür étanchéité de la porte	potenciál komfortu ovládania dverí potential door maneuverability comfort potenzieller Bedienkomfort der Tür potentiel de confort de commande de la porte	spojenie výplne s krídlom link to leaf panel Verbindung von Füllung und Flügel jonction du panneau et du battant			možnosť umiestniť madlo v ploche výplne ability to place a handle on the panel surface Möglichkeit der Griffunterbringung in der Füllungsfläche possibilité de placer une main courante dans la surface du panneau
					vložená/embedded/eingelegt/inséré	eFD	bFD	
●●○○○	▲▲	—————→	●●○○○○	●●○○○	✓	-	-	-
●●○○○	▲▲▲	—————→	●●○○○○	●●○○○	✓	-	-	✓
●●○○○	▲▲▲	—————→	●●○○○○	●●○○○	✓	-	-	✓
●●○○○	▲▲▲	—————→	●●○○○○	●●○○○	✓	-	-	✓
●●●●○	▲▲▲▲	—————→	●●○○○○	●●○○○	✓	-	-	-
●●●●○	▲▲▲▲	—————→	●●○○○○	●●○○○	✓	-	-	✓
●●●●○	▲▲▲▲	—————→	●●○○○○	●●○○○	✓	-	-	✓
●●●●○	▲▲▲▲	—————→	●●○○○○	●●○○○	✓	-	-	✓
-	-	-	-	-	-	-	-	-
●●●○○	▲▲▲	-----→	●●●●●	●●●●○	✓	-	-	✓
●●●○○	▲▲▲	-----→	●●●●●	●●●●○	✓	F / OM	-	✓
●●●○○	▲▲▲	-----→	●●●●●	●●●●○	✓	F / OM	-	✓
●●●○○	▲▲▲	-----→	●●●●●	●●●●○	✓	F / OM	DUO	✓
-	-	-	-	-	-	-	-	-
●●●●●	▲▲▲▲	-----→	●●●●●	●●●●○	✓	-	-	✓
●●●●●	▲▲▲▲	-----→	●●●●●	●●●●○	✓	F / OM	-	✓
●●●●●	▲▲▲▲	-----→	●●●●●	●●●●○	✓	F / OM	-	✓
●●●●●	▲▲▲▲	-----→	●●●●●	●●●●○	✓	F / OM	DUO	✓

Vložená výplň 



Dizajn exteriér:

- profil dverného krídla je po obvode priznaný
- dizajn dvernej výplne je viditeľne menší

Dizajn interiér:

- profil dverného krídla je po obvode priznaný
- dizajn dvernej výplne je viditeľne menší

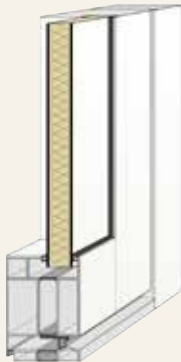
Teplotníka: parametre sú v rozmedzí od nízkych po priemerné.
Len ak je použité jadro F, tak sa znižujú sily, ktorými dverná výplň dokáže pôsobiť na krídlo pri teplotných rozdieloch

Embedded panels 



Exterior design:

- door leaf profile placed along the perimeter
- door panel design visibly smaller

Interior design:

- door leaf profile placed along the perimeter
- door panel design visibly smaller

Thermal Technology: parameters range from low to average.
Only when F Core is used, reducing the force that is caused by temperature differences acting on the door panel.

Eingelegte füllung  

Außen-design:

- Türflügelprofil entlang des Umfangs ist zulässig
- Design der Türfüllung ist sichtbar kleiner

Innen-design:

- Türflügelprofil entlang des Umfangs ist zulässig
- Design der Türfüllung ist sichtbar kleiner

Wärmetechnologie: Parameter bewegen sich im Bereich zwischen niedrig bis durchschnittlich.
Nur, wenn der Kern F verwendet wird, verringern sich die Kräfte, mit denen die Füllung bei Temperaturveränderungen auf den Flügel einwirkt.

Panneau inséré

Design extérieur:

- le profilé du battant de porte est reconnu sur le pourtour
- le design du panneau de porte est visiblement moins grand

Design intérieur:

- le profilé du battant de porte est reconnu sur le pourtour
- le design du panneau de porte est visiblement moins grand

Technique de chaleur: les paramètres sont dans la limite comprise entre les paramètres bas à moyens
Ce n'est qu'avec l'utilisation d'un noyau F que se diminuent les forces par lesquelles le panneau de porte arrive à agir sur le battant lors des différences de températures

eFD „einseitig Flügeldeckende“

Exteriér **Interiér**

Jednostranne pedsadená výplň s jadrom F a dodatkovým kotvením



Dizajn exteriér:

- profil dverného krídla je po obvode prekrytý výplňou
- dizajn dvernej výplne je viditeľne väčší

Dizajn interiér:

- profil dverného krídla je po obvode priznaný
- dizajn dvernej výplne je viditeľne menší

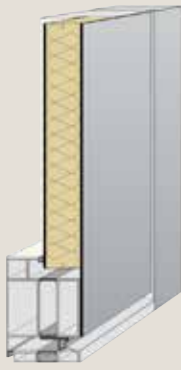
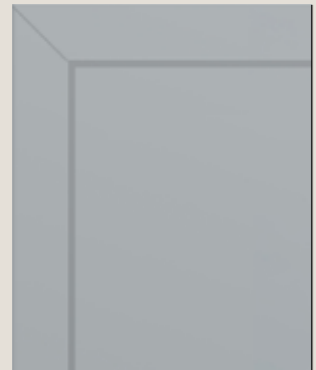
Teplotníka: parametre sú v rozmedzí od priemerných po veľmi dobré
Konštrukcia znižujúca sily, ktorými dverná výplň dokáže pôsobiť na krídlo pri teplotných rozdieloch
Bezpečnosť: výplň je celoobvodovo mechanicky prikotvená k profilu krídla
Určená pre modely výplní bez presklenia.

F Core and additional anchoring

Exterior design:

- door leaf profile padded along the perimeter
- door panel design visibly larger

Interior design:

- door leaf profile placed along the perimeter
- door panel design visibly smaller

Thermal Technology: parameters range from average to very good
Construction that reduces the force caused by temperature differences acting on the door panel.
Security: panel mechanically anchored to the leaf profile across the entire perimeter.
Designed for panel models without glass.

Einseitig hervorstehende Füllung mit Kern F und zusätzlicher Verankerung

Außen-design:

- Türflügelprofil wird entlang des Umfangs von der Füllung verdeckt
- Design der Türfüllung ist sichtbar größer

Innen-design:

- Türflügelprofil entlang des Umfangs ist zulässig
- Design der Türfüllung ist sichtbar kleiner

Wärmetechnologie: Parameter bewegen sich im Bereich zwischen durchschnittlich und sehr gut.
Konstruktion, welche die Kräfte, mit denen die Füllung bei Temperaturveränderungen auf den Flügel einzuwirken in der Lage ist, verringert.
Sicherheit: Die Füllung ist entlang des gesamten Umfangs im Flügelprofil verankert.
Bestimmt für Füllungsmodelle ohne Verglasung.

Panneau déplacé d'un côté avec noyau F et ancrage complémentaire

Design extérieur:

- le profilé du battant de porte est recouvert par le panneau sur le pourtour
- le design du panneau de porte est visiblement plus grand

Design intérieur:

- le profilé du battant de porte est reconnu sur le pourtour
- le design du panneau de porte est visiblement moins grand

Technique de chaleur: les paramètres sont dans la limite comprise entre les paramètres moyens à très bons.
Structure diminuant les forces par lesquelles le panneau de porte arrive à agir sur le battant lors des différences de températures
Sécurité: le panneau est ancré mécaniquement sur tout le pourtour au profilé du battant.
Destiné aux modèles de panneaux sans vitrage.

eFD „einseitig Flügeldeckende“

Exteriér **Interiér**

Jednostranne pedsadená výplň s OM systémom



Dizajn exteriér:

- profil dverného krídla je po obvode prekrytý výplňou
- dizajn dvernej výplne je viditeľne väčší

Dizajn interiér:

- profil dverného krídla je po obvode priznaný
- dizajn dvernej výplne je viditeľne menší

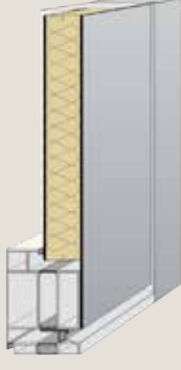
Teplotníka: parametre sú v rozmedzí od priemerných po veľmi dobré.
Konštrukcia znižujúca sily, ktorými dverná výplň dokáže pôsobiť na krídlo pri teplotných rozdieloch
Bezpečnosť: výplň je celoobvodovo mechanicky prikotvená k profilu krídla.
Možnosť výmeny izolačného zasklenia v prípade poškodenia: multifunkčná servisná medzivrstva.

OM system with the panel protruding from one side

Exterior design:

- door leaf profile padded along the perimeter
- door panel design visibly larger

Interior design:

- door leaf profile placed along the perimeter
- door panel design visibly smaller

Thermal Technology: parameters range from average to very good
Construction that reduces the force caused by temperature differences acting on the door panel.
Security: panel mechanically anchored to the leaf profile across the entire perimeter.
Glass can be exchanged if damaged: multifunctional interlayer servicing.

Einseitig hervorstehende Füllung mit OM-System

Außen-design:

- Türflügelprofil wird entlang des Umfangs von der Füllung verdeckt
- Design der Türfüllung ist sichtbar größer

Innen-design:

- Türflügelprofil entlang des Umfangs ist zulässig
- Design der Türfüllung ist sichtbar kleiner

Wärmetechnologie: Parameter bewegen sich im Bereich zwischen durchschnittlich und sehr gut.
Konstruktion, welche die Kräfte, mit denen die Füllung bei Temperaturveränderungen auf den Flügel einzuwirken in der Lage ist, verringert.
Sicherheit: Die Füllung ist entlang des gesamten Umfangs mechanisch im Flügelprofil verankert.
Möglichkeit des Austauschs des Isolierglases im Falle der Beschädigung: multifunktionelle Service-Zwischenschicht.

Panneau déplacé d'un côté avec système OM

Design extérieur:

- le profilé du battant de porte est recouvert par le panneau sur le pourtour
- le design du panneau de porte est visiblement plus grand

Design intérieur:

- le profilé du battant de porte est reconnu sur le pourtour
- le design du panneau de porte est visiblement moins grand

Technique de chaleur: les paramètres sont dans la limite comprise entre les paramètres moyens à très bons.
Structure diminuant les forces par lesquelles le panneau de porte arrive à agir sur le battant lors des différences de températures
Sécurité: le panneau est ancré mécaniquement sur tout le pourtour au profilé du battant.
Possibilité de remplacement d'un vitrage d'isolation en cas d'endommagement: couche intermédiaire multifonctionnelle de service.

bFD „beidseitig Flügeldeckende“

Exteriér **Interiér**

Obojstranne pedsadená výplň s DUO systémom



Dizajn exteriér:

- profil dverného krídla je po obvode prekrytý výplňou
- dizajn dvernej výplne je viditeľne väčší

Dizajn interiér:

- profil dverného krídla je po obvode prekrytý výplňou
- dizajn dvernej výplne je viditeľne väčší

Teplotníka: parametre sú v rozmedzí od veľmi dobrých po vynikajúce.
Konštrukcia znižujúca sily, ktorými dverná výplň dokáže pôsobiť na krídlo pri teplotných rozdieloch.
Bezpečnosť: výplň je celoobvodovo mechanicky prikotvená k profilu krídla.
Možnosť výmeny izolačného zasklenia v prípade poškodenia: multifunkčná servisná medzivrstva.

DUO system with the panel protruding from both sides

Exterior design:

- door leaf profile padded along the perimeter
- door panel design visibly larger

Interior design:

- door leaf profile padded along the perimeter
- door panel design visibly larger

Thermal Technology: parameters range from very good to excellent.
Construction that reduces the force caused by temperature differences acting on the door panel.
Security: panel mechanically anchored to the leaf profile across the entire perimeter.
Glass can be exchanged if damaged: multifunctional interlayer servicing.

Beidseitig hervorstehende Füllung mit DUO-System

Außen-design:

- Türflügelprofil wird entlang des Umfangs von der Füllung verdeckt
- Design der Türfüllung ist sichtbar größer

Innen-design:

- Türflügelprofil wird entlang des Umfangs von der Füllung verdeckt
- Design der Türfüllung ist sichtbar größer

Wärmetechnologie: Parameter bewegen sich im Bereich zwischen sehr gut und ausgezeichnet.
Konstruktion, welche die Kräfte, mit denen die Füllung bei Temperaturveränderungen auf den Flügel einzuwirken in der Lage ist, verringert.
Sicherheit: Die Füllung ist entlang des gesamten Umfangs mechanisch im Flügelprofil verankert.
Möglichkeit des Austauschs des Isolierglases im Falle der Beschädigung: multifunktionelle Service-Zwischenschicht.

Panneau déplacé des deux côtés avec système DUO

Design extérieur:

- le profilé du battant de porte est recouvert par le panneau sur le pourtour
- le design du panneau de porte est visiblement plus grand

Design intérieur:

- le profilé du battant de porte est recouvert par le panneau sur le pourtour
- le design du panneau de porte est visiblement plus grand

Technique de chaleur: les paramètres sont dans la limite comprise entre les paramètres très bons à excellents.
Structure diminuant les forces par lesquelles le panneau de porte arrive à agir sur le battant lors des différences de températures
Sécurité: le panneau est ancré mécaniquement sur tout le pourtour au profilé du battant.
Possibilité de remplacement d'un vitrage d'isolation en cas d'endommagement: couche intermédiaire multifonctionnelle de service.

Na nasledujúcich stránkach každá hliníková výplň zobrazená ako FD (alebo aj ako vložená) predstavuje v skutočnosti možné prevedenie eFD alebo bFD, keďže pri jednostrannom zobrazení z exteriéru sú prevedenia eFD a bFD zhodné.

The following pages show each aluminum panel as FD (or embedded) although it can also be eFD or bFD designed because either would appear identical when the door is viewed from the outside.

Auf den nachfolgenden Seiten ist jede Aluminium-Füllung als FD abgebildet (oder bereits als eingelegte Füllung). Tatsächlich sind die möglichen Ausführungen eFD oder bFD dargestellt, da bei einseitiger Abbildung der Außenansicht die Ausführungen eFD und bFD identisch sind.

Sur les pages suivantes, chaque panneau aluminium affiché en tant que FD (ou en tant qu'inséré) représente en réalité une version possible eFD ou bFD, étant donné que les versions eFD et bFD sont similaires lors de l'affichage unilatéral de l'extérieur.

GAVA aluminium

Reprodukcia farieb je len približná / Colour rendering is only approximate / Die Farbwiedergabe ist nur annähernd / La reproduction des couleurs n'est qu'approximative



Povrchy RAL farieb

Štrukturovaná RAL farba		Hladká RAL farba	
Plusy	Minusy	Plusy	Minusy
<ul style="list-style-type: none"> + Exkluzívny vzhľad + Vyššia odolnosť proti vzniku jemných škrabancov + Znížená viditeľnosť odtlačkov prstov + Po umytí alebo daždi kvapky nezanechávajú stopy + Najbližšia podobnosť k jednofarebným lamináciám s jemne zrnitou štruktúrou „smooth“ 	<ul style="list-style-type: none"> - Zhoršená prílnavosť ochranných a krycích fólií 	<ul style="list-style-type: none"> + Viac dostupných farieb + Možnosť preleštenia jemných škrabancov 	<ul style="list-style-type: none"> - Vysoká citlivosť na škrabance - Po daždi a umývaní ostávajú kvapky šmuhy <ul style="list-style-type: none"> - treba leštiť = riziko vzniku jemných škrabancov - Pri tmavých farbách šmuhy od odtlačkov prstov - Na povrchu je viac viditeľné znečistenie od prachu - Pri pozorovaní z blízka v lome svetla efekt „pomarančového povrchu“
Štrukturovaný povrch		Hladký povrch zamatový lesk 60-80% stupňa lesku	



AI

Aluminium

- 1** Pieskované sklo
Sandblasted glass
Sandgestrahtes Glas
Verre dépoli
- 8** Aplikácia
Application
Applikation
Application
- 10** Intarzia
Inlay
Intarsie
Incrustation
- 11** Drážka
Groove
Nut
Rainure
- 15** Madlo v ploche výpne
Panel surface handle
Griff in Füllungsfläche
Main courante dans la surface
du panneau



GAVA 417L
11 15



GAVA 417L FD
11 15 **1** P12 INV



GAVA 512 FD
8 15



GAVA 514
10 11 15



GAVA 512
8



GAVA 513
8 15



GAVA 511
8 15



GAVA 490 FD
8



GAVA 490 FD
8 15



GAVA 491
8



GAVA 492 FD
8





GAVA 402 FD
11 15



GAVA 515 FD
10 15 1 Alaba INV



GAVA 405L FD
11



GAVA 528
11 15 1 Inio INV



GAVA 527 FD
11 15 1 P12



GAVA 401L FD
11 15 1 Zali



GAVA 401
11



GAVA 488a
8



GAVA 413b
8 11



GAVA 464b
12



GAVA 413 FD
9 11 15

AI

Aluminium

- 1 Pieskované sklo
Sandblasted glass
Sandgestrahtes Glas
Verre dépoli
- 8 Aplikácia
Application
Applikation
- 9 Aplikácia - 2. farba
2nd color application
Applikation - 2. Farbe
Application - 2ème couleur
- 10 Intarzia
Inlay
Intarsie
Incrustation
- 11 Drážka
Groove
Nut
Rainure
- 12 Reliéfný profil
Relief profile
Reliefprofil
Profilé à relief
- 15 Madlo v ploche výpne
Panel surface handle
Griff in Füllungsfläche
Main courante dans la surface
du panneau

GAVA aluminium



13 Tyčový profil / Bar profile
Stangenprofil / Profilé linéaire
detail

AI

Aluminium

- 1** Pieskované sklo
Sandblasted glass
Sandgestrahtes Glas
Verre dépoli
- 8** Aplikácia
Application
Applikation
Application
- 10** Intarzia
Inlay
Intarsie
Incrustation
- 11** Drážka
Groove
Nut
Rainure
- 13** Tyčový profil
Bar profile
Stangenprofil
Profilé linéaire
- 15** Madlo v ploche výpne
Panel surface handle
Griff in Füllungsfläche
Main courante dans la surface
du panneau



GAVA 524
10 15 **1** P12



GAVA 523 FD
10 15 **1** P12 INV



GAVA 522 FD
10 11 15



GAVA 412 FD
8 11 15



GAVA 525
10 15

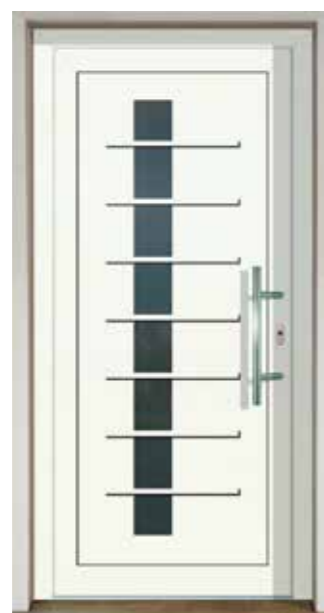

GAVA 473L
13



GAVA 526
13 **1** P20 INV



GAVA 479 FD
13



GAVA 451
8 11



GAVA 451 FD
8 11



GAVA 412b
15



GAVA aluminium



AI

Aluminium

- 1** Pieskové sklo
Sandblasted glass
Sandgestrahtes Glas
Verre dépoli
- 9** Aplikácia - 2. farba
2nd color application
Applikation - 2. Farbe
Application - 2ème couleur
- 11** Drážka
Groove
Nut
Rainure
- 12** Reliéfný profil
Relief profile
Reliefprofil
Profilé à relief
- 15** Madlo v ploche výpne
Panel surface handle
Griff in Füllungsfläche
Main courante dans la surface
du panneau



GAVA 516
11 15



GAVA 466L
11 12 15



GAVA 465
11 12



GAVA 519
11 15 **1** P12 INV



GAVA 520 FD
11 **1** Ebias



GAVA 419 FD
11 15



GAVA 418
11 15



GAVA 517
11



GAVA 410 FD
11



GAVA 414L FD
9 11 15



GAVA 411 FD
9 11



GAVA 521 FD
9 11 15



GAVA 418 FD
11 15 **1** P12 INV



11 Drážka/Groove/Nut/Rainure
detail

AI

Aluminium

- 1 Pieskované sklo
Sandblasted glass
Sandgestrahltes Glas
Verre dépoli
- 10 intarzia
Inlay
Intarsie
Incrustation
- 11 Drážka
Groove
Nut
Rainure
- 13 Týčový profil
Bar profile
Stangenprofil
Profilé linéaire
- 15 Madlo v ploche výpne
Panel surface handle
Griff in Füllungsfläche
Main courante dans la surface
du panneau
- 19 Týčový profil - 2.farba
Bar profile - 2nd color
Stangenprofil - 2. Farbe
Profilé linéaire - 2ème couleur



GAVA 400 FD

11 15

1 P12



GAVA 542

10 15

1 Forto



GAVA 470b

19

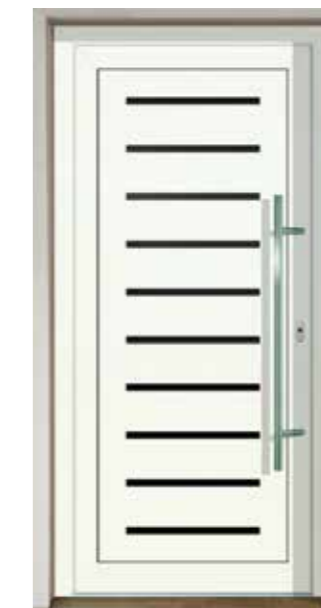

GAVA 470b

19



GAVA 470a FD

13



GAVA 544 FD

10 15

1 P12 INV



GAVA 544

10

1 P12



GAVA 543

10 15



GAVA 400

11 15



GAVA 403 FD

1 P12 INV

11 15

1 P12 INV



GAVA 540

11 15



GAVA 541 FD

11 15

1 P12



GAVA 543

10 15

1 P12 INV

GAVA aluminium



AI

Aluminium

- 1** Pieskované sklo
Sandblasted glass
Sandgestrahltes Glas
Verre dépoli
- 8** Aplikácia
Application
Applikation
- 9** Aplikácia – 2. farba
2nd color application
Applikation – 2. Farbe
Applikation – 2ème couleur
- 11** Drážka
Groove
Nut
Rainure
- 15** Madlo v ploche výplne
Panel surface handle
Griff in Füllungsfläche
Main courante dans la surface
du panneau



GAVA 553
11 15



GAVA 553 FD
11 15 1 P12



GAVA 554 FD
8 15 1 P60 INV



GAVA 416c
8 11



GAVA 494 FD
8



GAVA 495 FD
8



GAVA 416c
8 11



GAVA 495
8



GAVA 416b
11 1 P12



GAVA 416b FD
11 15



GAVA 416a FD
9 11 15

GAVA aluminium

8 Aplikácia
detail



GAVA 546
8 15



GAVA 546 FD
8 15



GAVA 546
8 15 1 Tezami INV



GAVA 547 FD
8 15



GAVA 547
8 15 1 P60



GAVA 550 FD
8 10 11 15



GAVA 550
8 10 11 15 1 Orsi



GAVA 548 FD
9 11 14 15 1 Abos INV



GAVA 551a
8 11 15 1 P12 INV



GAVA 551b FD
8 11 15



GAVA 551a
8 11 15

AI Aluminium

- 1 Pieskované sklo
Sandblasted glass
Sandgestrahtes Glas
Verre dépoli
- 8 Aplikácia
Application
Applikation
Application
- 9 Aplikácia - 2. farba
2nd color application
Applikation - 2. Farbe
Application - 2ème couleur
- 10 Intarzia
Inlay
Intarsie
Incrustation
- 11 Drážka
Groove
Nut
Rainure
- 14 Gravír na hliniku + vysoký lesk
Engraved in aluminium + high gloss
Gravur auf Aluminium + Hochglanz
Gravure sur aluminium + haute brillance
- 15 Madlo v ploche výpne
Panel surface handle
Griff in Füllungsfläche
Main courante dans la surface
du panneau



GAVA 497 FD
8



GAVA 497
8



GAVA 556 FD
10 11 15 1 P12 INV



GAVA 556
10 11 1 P12



GAVA 448 FD
8 15



GAVA 447
9 11



GAVA 424
8 11 15



GAVA 422
9 11



GAVA 422 FD
9 11 15



GAVA 423
11



GAVA 408 FD
11



GAVA 423L FD
11 15



AI

Aluminium

- 1** Pieskované sklo
Sandblasted glass
Sandgestrahltes Glas
Verre dépoli
- 8** Aplikácia
Application
Applikation
Application
- 9** Aplikácia - 2. farba
2nd color application
Applikation - 2. Farbe
Application - 2ème couleur
- 10** Intarzia
Inlay
Intarsie
Incrustation
- 11** Drážka
Groove
Nut
Rainure
- 15** Madlo v ploche výpne
Panel surface handle
Griff in Füllungsfläche
Main courante dans la surface
du panneau

GAVA aluminium



AI

Aluminium

- 1** Pieskované sklo
Sandblasted glass
Sandgestrahltes Glas
Verre dépoli
- 8** Aplikácia
Application
Applikation
Application
- 10** Intarzia
Inlay
Intarsie
Incrustation
- 11** Drážka
Groove
Nut
Rainure
- 15** Madlo v ploche výpne
Panel surface handle
Griff in Füllungsfläche
Main courante dans la surface
du panneau



GAVA 499 FD
11 15

1 Ebias INV



GAVA 428L
11

1 P12 INV



GAVA 428L FD
11 15

1 P12



GAVA 442
8 11



GAVA 429
8 15



GAVA 427L FD
11



GAVA 498 FD
10 15



GAVA 498
10



GAVA 426
11 15



GAVA 426 FD
11 15

1 Ayo

GAVA aluminium



12 Reliéfný profil / Relief profile /
Reliefprofil / Profilé à relief
detail



GAVA 463a
11 12 15

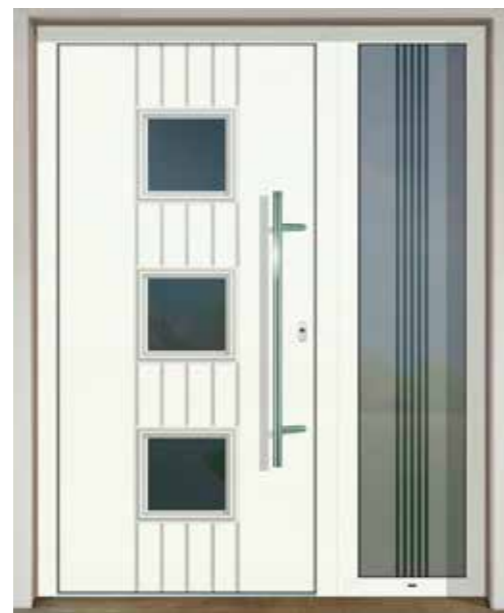

GAVA 463a FD
11 12



GAVA 460
12



GAVA 461 FD
12



GAVA 469
11 12



GAVA 460 FD
12 15



GAVA 441
11



GAVA 441 FD
11 15



GAVA 445
11



GAVA 443L
8 11



GAVA 443 FD
8 11



GAVA 444bL
8 11 15



GAVA 445L FD
11 15

AI

Aluminium

- 1 Pieskované sklo
Sandblasted glass
Sandgestrahtes Glas
Verre dépoli
- 8 Aplikácia
Application
Applikation
Application
- 11 Drážka
Groove
Nut
Rainure
- 12 Reliéfný profil
Relief profile
Reliefprofil
Profilé à relief
- 15 Madlo v ploche výpne
Panel surface handle
Griff in Füllungsfläche
Main courante dans la surface
du panneau



GAVA aluminium



AI

Aluminium

- 1** Pieskované sklo
Sandblasted glass
Sandgestrahltes Glas
Verre dépoli
- 8** Aplikácia
Application
Applikation
Application
- 10** Intarzia
Inlay
Intarsie
Incrustation
- 11** Drážka
Groove
Nut
Rainure
- 15** Madlo v ploche výplne
Panel surface handle
Griff in Füllungsfläche
Main courante dans la surface
du panneau



GAVA 560 FD
8 11 15

1 P12 INV



GAVA 567
8 15



GAVA 567 FD
8 15



GAVA 562 FD
11 15 **1** Ebias INV



GAVA 562
11 15

1 Ebias



GAVA 561b
10 15



GAVA 561a
11

1 P12



GAVA 561a FD
11 15



GAVA 568 FD
11 15

1 Taipu



GAVA 568
11 15

1 Taipu INV



14 Gravír detail



GAVA 565a
9 14



GAVA 565b
9 14

1 Midely



GAVA 565c FD
9 14 15



GAVA 564a FD
9 14 15



GAVA 564b FD
9 14 15



GAVA 565d FD
9 14 15



GAVA 564c
9 14 15



GAVA 564d
9 14 15



GAVA 486 FD
14



GAVA 486
14



GAVA 487 FD
8 14



GAVA 487
8 14

AI

Aluminium

- 1 Pieskované sklo
Sandblasted glass
Sandgestrahtes Glas
Verre dépoli
- 8 Aplikácia
Application
Applikation
Application
- 9 Aplikácia - 2. farba
2nd color application
Applikation - 2. Farbe
Application - 2ème couleur
- 14 Gravír na hliníku + vysoký lesk
Engraved in aluminium + high gloss
Gravur auf Aluminium + Hochglanz
Gravure sur aluminium + haute brillance
- 15 Madlo v ploche výplne
Panel surface handle
Griff in Füllungsfläche
Main courante dans la surface du panneau



GAVA aluminium



AI

Aluminium

- 1** Pieskové sklo
Sandblasted glass
Sandgestrahltes Glas
Verre dépoli
- 8** Aplikácia
Application
Applikation
Application
- 10** Intarzia
Inlay
Intarsie
Incrustation
- 11** Drážka
Groove
Nut
Rainure
- 15** Madlo v ploche výplne
Panel surface handle
Griff in Füllungsfläche
Main courante dans la surface
du panneau



GAVA 576 FD

10 15 1 Myre

1 Myre



GAVA 578b

10 15

1 Ibon INV



GAVA 573

11 15



GAVA 572 FD

11 15

1 Cruzi INV



GAVA 578a FD

11 15



GAVA 570 FD

11 15

1 Laryo INV



GAVA 579

8 15



GAVA 576

10 15



GAVA 575

1 P12

10 15

1 Asil

1 P12



GAVA 575 FD

10 15



GAVA 577

8 15



GAVA 571

11 15

GAVA aluminium



GAVA 583
8 10 15



GAVA 583 FD
8 10 15



GAVA 409 FD
11



GAVA 481
14 15



GAVA 484a FD
8 14 15



GAVA 437c
8 11



GAVA 582 FD
11 15



GAVA 582
11 15



GAVA 438a
11 15



GAVA 438a FD
11 P12 INV

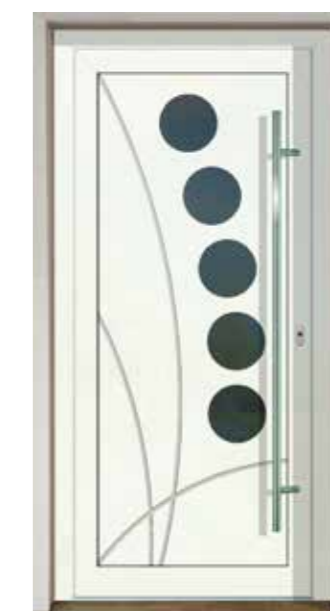

GAVA 437a
11



GAVA 437a FD
11



AI

Aluminium

- 1** Pieskové sklo
Sandblasted glass
Sandgestrahtes Glas
Verre dépoli
- 8** Aplikácia
Application
Application
Application
- 10** Intarzia
Inlay
Intarsie
Incrustation
- 11** Drážka
Groove
Nut
Rainure
- 14** Gravír na hliníku + vysoký lesk
Engraved in aluminium + high gloss
Gravur auf Aluminium + Hochglanz
Gravure sur aluminium + haute brillance
- 15** Madlo v ploche výpne
Panel surface handle
Griff in Füllungsfläche
Main courante dans la surface du panneau

GAVA aluminium



GAVA 585 FD
11



GAVA 586 FD
8 15



GAVA 435b
8 11 15



GAVA 587 FD
8 1 P60



GAVA 589
8 15 1 Giro INV



GAVA 580
8 15



GAVA 581
8 15



GAVA 430L
11 15



GAVA 580 FD
8 15



GAVA 431
9 11

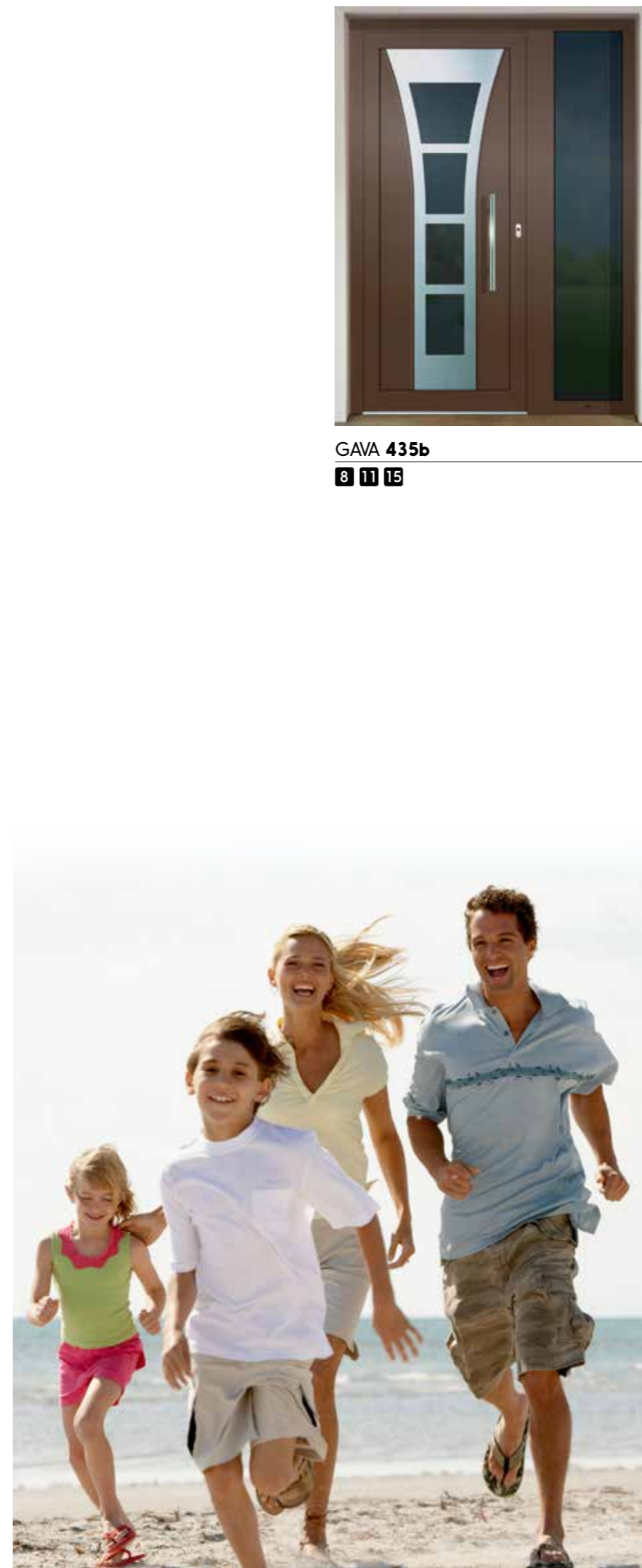

GAVA 433 FD
9 11

AI

Aluminium

- 1 Pieskované sklo
Sandblasted glass
Sandgestrahltes Glas
Verre dépoli
- 8 Aplikácia
Application
Applikation
Application
- 9 Aplikácia - 2. farba
2nd color application
Applikation - 2. Farbe
Application - 2ème couleur
- 11 Drážka
Groove
Nut
Rainure
- 15 Madlo v ploche výplne
Panel surface handle
Griff in Füllungsfläche
Main courante dans la surface
du panneau

GAVA aluminium

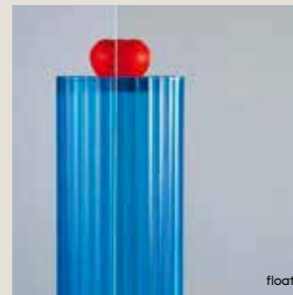

float



planitherm



stopsol bronze



stopsol supersilver

Sklá čire a reflexné:

Základným sklom je hladké plavené čire sklo float. Ďalšie sa vyznačujú pokoveniami, ktoré ovplyvňujú vizuálne a teplo technické parametre. Pre pokovené sklá platí, že smerom do priestoru s lepšimi svetelnými podmienkami vytvárajú zrkadlaci efekt.



Clear and reflective glass:

The basic glass is smooth float clear glass. Other glasses are metal plated, resulting in different visual and thermal properties. Metal plated glass results in mirroring effect in the direction of the space with better lighting conditions.



Klares und reflektierendes Glas:

Als Grundlage dient glattes, klares Floatglas. Anderes Glas zeichnet sich durch Metallbeschichtung aus, was die visuellen und wärmetechnischen Parameter beeinflusst. Für metallbeschichtetes Glas gilt, dass bei Räumen mit besseren Lichtverhältnissen zum Rauminneren hin ein Spiegeleffekt entsteht.



Verres clairs et réfléchissants:

Le verre de base est du verre clair lisse float. Les autres se caractérisent par leurs couches, qui influencent les paramètres visuels et techniques pour la chaleur. Pour les verres à couches s'applique le fait qu'ils créent un effet miroir en direction de l'espace ayant de meilleures conditions lumineuses.



matelux



dubová kôra



crepi



chinchla



master carre



master point

Sklá matované/ornamentné:

Chemickým leptaním alebo reliéfnym tvarovaním zasklenia sú dosiahnuté rôzne celoplošné vzorovania pri zachovaní priepustnosti svetla. Vzorovania môžu byť bez orientácie alebo orientované v určitom smere. Tieto sklá ponúkajú vysokú mieru súkromia.

Matt/decorated glass:

Chemical etching or embossing of the glass pane results in various surface patterns while maintaining translucency. The pattern may be non-oriented or direction-oriented. These types of glass offer a high degree of privacy.

Mattiertes Glas/Ornamentglas:

Durch chemisches Ätzen oder Formung von Reliefs an der Verglasung werden verschiedene ganzflächige Muster bei gleichzeitig aufrechterhaltener Lichtdurchlässigkeit erzielt. Die Muster können zufällig sein oder mit Ausrichtung in einer bestimmten Richtung. Diese Glasscheiben bieten einen hohen Grad an Privatsphäre.

Verres mats/d'ornement:

Par gravure chimique ou façonnage du relief du vitrage sont obtenus divers dessins sur toute la surface en gardant le passage de la lumière. Les dessins peuvent être sans orientation ou orientés dans un certain sens. Ces verres offrent un niveau élevé d'intimité.

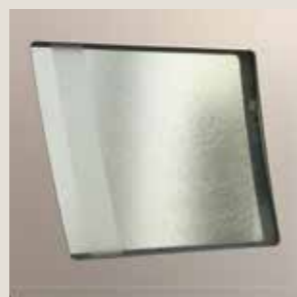
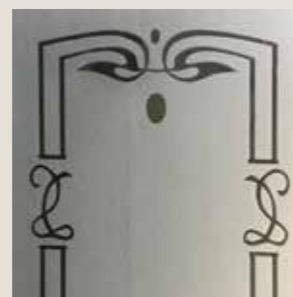
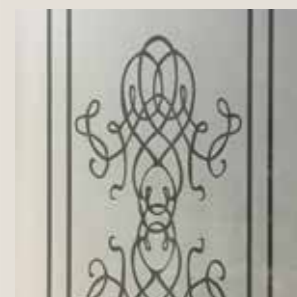

Sklá pieskované motívy:

Striedaním opieskovaných a čirých plôch je možné vytvoriť požadovaný motív. Opieskovaním sa dosahuje nepriehľadnosť a beloba zasklenia. Zámenou čirých a pieskovaných plôch vytvárame inverzný (negatívny) dizajn zasklenia.

Sanded decoration glass:

Alternating sanded and clear areas create the desired motif. Sanding results in opaque and white shades of glazing. Alternate clear and sanded areas result in an inverted (negative) glazing design.

Glas mit sandgestrahlten Motiven:

Durch Abwechslung sandgestrahlter und transparenter Flächen können gewünschte Motive geschaffen werden. Durch Sandstrahlen wird Blicklichkeit und ein Milchglaseffekt an der Verglasung erreicht. Durch Austausch transparenter und sandgestrahlter Flächen schaffen wir ein inverses (negatives) Scheibendesign.

Verres dépolis avec motifs:

Par l'alternance de surfaces dépolies et claires, il est possible de créer le motif réclame. Par le dépolissage s'obtient une opacité et une blancheur du vitrage. Par la variation de surfaces claires et dépolies, nous créons un design inversé (négatif) du vitrage.



Decorglass



Decorglass



Tiffany



Tiffany



Decorglass



Decorglass

Sklá vitrážne - Tiffany a Decorglass:

Tiffany: Pomocou cinovania sa spájajú malé či väčšie kusky rôznych druhov skiel a tým sa vytvára výtvarný motív zasklenia. Decorglass: Na podkladové sklo sa lepia fólie, ktoré imitujú farebné alebo štruktúrované sklo. Spojie sa prelepija upravenou olovenou páskou.

Stained glass - Tiffany and Decorglass:

Tiffany: Tin is used to connect small and larger fragments of various glass types, thus creating a graphic design. Decorglass: Foils, imitating coloured or structured glass, are applied to the base glass pane. The joints are covered with modified lead tape.

Vitrage-Glas - Tiffany und Dekorglas:

Tiffany: Durch Verzinnen werden kleine und größere Stücke verschiedener Glasarten miteinander verbunden und dadurch das Scheibenmotiv geschaffen. Decorglas: Auf eine Glasbasis wird Folie geklebt, die Bunt- oder Strukturglas imitiert. Stöße werden mit speziellem Bleiband überklebt.

Verres pour vitraux - Tiffany et Decorglass:

Tiffany: A l'aide d'un étamage, des parties petites ou plus grandes de divers types de verres sont jointes, un motif artistique de vitrage se créant ainsi. Decorglass: Sur le verre de fond se collent des feuilles qui imitent le verre de couleur ou structuré. Les joints se collent par une bande de plomb ajustée.

Aktuálna ponuka zasklení: www.gavaplast.sk The current range of glass panes: www.gavaplast.com Aktuelles Angebot an Verglasungen: www.gavaplast.eu Offre actuelle de vitrages: www.gavaplast.be



Teplý rámik:

K najväčšej tepelnej strate izolačných zasklení dochádza na okrajoch skiel. Dištančné rámičky Super Spacer® znižujú únik tepla na okrajoch zasklenia o cca -70 % oproti riešeniam s kovovými dištančnými rámičkami. Vzhľadom na fakt, že v dverných výplniach sú používané malé plochy skiel s veľkým množstvom obvodu, je tento detail obzvlášť dôležitý.

Warm Edge:

The majority of thermal losses occur at the edges of glazing. Super Spacer® spacer frames reduce the amount of escaped heat at the edges of the glass pane by about 70 % compared to designs with metallic spacers. Due to the fact that small surfaces of glass with a long circumference are used in door glazing, this detail is especially important.

Warme Kante:

Zu den größten Wärmeverlusten bei Isolierverglasungen kommt es an den Scheibenrändern. Distanzrahmen Super Spacer® verringern den Wärmeverlust am Scheibenrand um ca. 70 % gegenüber Lösungen mit Metall-Distanzrahmen. Angesichts der Tatsache, dass in Türfüllungen kleine Glasflächen mit großer Randlänge verwendet werden, ist dieses Detail besonders wichtig.

Bord chaud:

La perte thermique la plus importante des vitrages d'isolation a lieu sur les bords des vitres. Les barres d'espacement Super Spacer® diminuent la fuite de chaleur sur le bord du vitrage d'environ -70 % par rapport aux solutions avec des barres d'espacement en métal. Etant donné que de petites surfaces de verres avec une grande quantité de pourtour sont utilisées dans les panneaux de portes, ce détail est particulièrement important.



Svetlíkové zasklenia



Našou snahou je pomôcť vám s riešením nielen samotnej dvernej výplne, ale upriamujeme pozornosť na vstup do objektu ako celok, ktorý môžu tvoriť aj zasklenia v bočných prípadne horných prísvetlíkoch. Okrem dodávky výplne do dverného kridla vieme poskytnúť aj dodávku izolačných zasklení či už čírych, vzorovaných, s pieskovanými motívami prípadne vitrážnych s dizajnom harmonizujúcim s hlavnou výplňou. Zasklenia dodávame ako izolačné dvojsklá alebo izolačné trojsklá vo vami požadovaných rozmeroch.



Transom glazing



We will try to help you find a solution not only for door glazing but we also focus on the entrance to the building as a whole, including the glazing of side or top transom panels. In addition to door glazing, we also offer insulation glazing - clear or patterned, with sanded motifs or stained-glass design harmonized to the main glazing. The glazing is based on double or triple-pane insulation glazing of the desired dimensions.

Verglasung von Lichtdurchlässen



Wir bemühen uns, Ihnen bei der Lösung nicht nur allein der Türfüllung zu helfen, sondern richten das Augenmerk auf den Zugang zum Objekt als Ganzes, der auch mit seitlichen oder oben angeordneten Lichtdurchlässen verglast sein kann. Neben Füllungen für die Türflügel sind wir in der Lage, auch Isolierverglasungen zu liefern, seien es transparente, gemusterte, mit sandgestrahlten Motiven oder mit Glas-Vitrage versehene Scheiben, deren Design mit der Hauptfüllung harmonisiert. Die Verglasung liefern wir als Isolier-Doppelglas oder als Isolier-Dreifachglas in den von Ihnen geforderten Abmessungen.

Vitrage pour lucarnes



Nous nous efforçons de vous aider dans la résolution non seulement du panneau de porte lui-même, mais portons aussi notre attention sur l'entrée dans le bâtiment dans son ensemble, que peuvent aussi influencer des vitrages dans les lucarnes latérales ou de plafond. Hormis la livraison de panneaux dans le battant de porte, nous pouvons aussi fournir la livraison de vitres d'isolation, qu'elles soient claires, avec des dessins, avec des motifs dépolis, le cas échéant pour les vitraux, avec un design s'harmonisant avec le panneau central. Nous livrons le vitrage en tant que double vitrage isolant ou triple vitrage isolant dans les dimensions que vous réclamez.



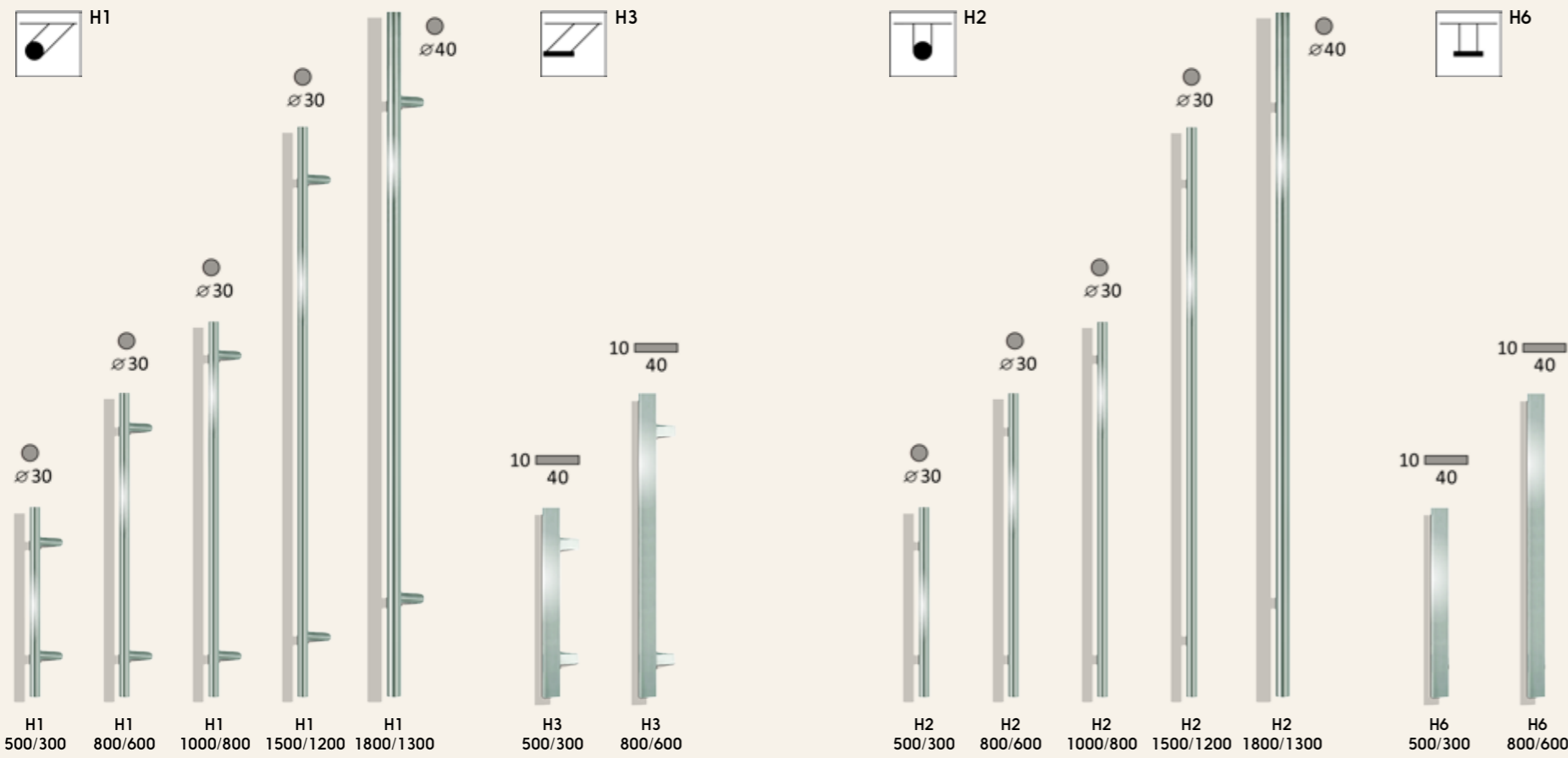

KOVANIE

Dverné madlá
 Vkusný dizajn dverí tvorený zvoleným modelom výplne a k nemu vhodne zosúladeným madlom osloví každého užívateľa. Vchodové dvere s madlom sú honosnejšie a stávajú sa pýchou majiteľa. Dverné madlo poskytuje vyšší komfort pri obsluhu dverí, jeho poloha sa dá určiť aj podľa potreby zákazníka. Dôležité je pri tom myslieť na dostatočný manipulačný priestor v okolí vložky zámku. Z dizajnového i funkčného hľadiska je vhodnou voľbou madlo osadené do plochy výplne.

Madlá so šikmým uchytením (vyosené)
 - montujú sa na dverné krídlo
 - nie je možné ich montovať do dvernej výplne

Madlá s priamym uchytením
 - montujú sa do plochy dvernej výplne (nutná príprava výstupu pod madlom)
 - nie je možné osadiť ich na krídlo dverí pri dnu otváracích dverách

Rozmery madiel sú uvedené v milimetroch. Dverné madlá s označením „H“ sú skladové. Madlá je možné dodať aj v sade: madlo + rozety + kľučka.

FITTINGS

Door handle bars
 A tasteful door design consisting of the selected model of glazing and a suitable fitted door handle bar should be attractive to every user. Entrance doors with handle bars are more opulent and make their owner rightly proud. A door handle bar offers greater operating comfort as its positioning can be determined according to the customer's needs. It is important to consider sufficient operating space around the lock insert. From a design and function viewpoint, a handle bar installed in the glazing pane is a suitable choice.

Oblique handle bars
 - installed on door leaf
 - cannot be installed in the glazing pane

Direct mount handle bars
 - installed in the glazing pane (reinforcement must be installed under handle bar)
 - cannot be installed on door leaf in case of door opening to the inside

Handle bar dimensions are specified in millimetres. "H" door handle bars are in stock. Handle bars can be supplied in sets of handle bar + plates + levers.

BESCHLÄGE

Türgriffe
 Ein durch das gewählte Modell der Füllung geschaffenes geschmackvolles Türdesign mit darauf abgestimmtem Griff spricht jeden Benutzer an. Eingangstüren mit Griff sind schöner und werden zum Stolz des Besitzers. Türgriffe bieten einen höheren Komfort bei der Bedienung der Tür. Ihre Position kann nach den Bedürfnissen des Kunden festgelegt werden. Wichtig ist, dabei an ausreichendem Manipulationsraum in der Umgebung des Schlosses zu denken. Bezüglich Design und Funktionalität ist ein in die Fläche der Türfüllung eingesetzter Griff die geeignete Wahl.

Griff mit schräger Befestigung (aus der Achse)
 - wird an den Türflügel montiert
 - kann nicht in die Türfüllung montiert werden

Griff mit gerader Befestigung
 - wird in die Fläche der Türfüllung montiert (Anbringung einer Verstärkung unter dem Griff notwendig)
 - kann bei nach innen öffnender Tür nicht am Türflügel montiert werden

Die Abmessungen der Griffe sind in Millimetern angegeben. Türgriffe mit der Bezeichnung „H“ sind im Lager vorrätig. Die Griffe können auch in Sets Griff + Rosette + Klinke geliefert werden.

FERRURE

Barres de poussée
 Un design de goût pour les portes, formé par un modèle choisi de panneau et une barre de poussée bien harmonisée avec lui, retiendra l'attention de chaque utilisateur. Une porte d'entrée avec une barre de poussée est plus somptueuse et devient la fierté de son propriétaire. La barre de poussée fournit un plus grand confort lors de l'utilisation de la porte, sa position pouvant être déterminée également selon le besoin du client. Il est important lors de ce choix de penser à avoir assez d'espace de manipulation dans les environs du cylindre de serrure. Du point de vue du design et de la fonctionnalité, une barre de poussée installée dans la surface du panneau est un bon choix.

Barres avec saisie en biais (désaxée)
 - se montent sur le battant de porte
 - il n'est pas possible de les monter dans le panneau de porte

Barres avec saisie droite
 - se montent dans la surface du panneau de porte (préparation d'un renforcement sous la barre nécessaire)
 - il n'est pas possible de les monter sur un battant de porte sur le fond d'une porte d'ouverture

Les dimensions des barres sont indiquées en millimètres. Les barres de poussée avec désignation "H" sont en stock. Les barres peuvent aussi être livrées dans des kits barre + rosettes + poignées.

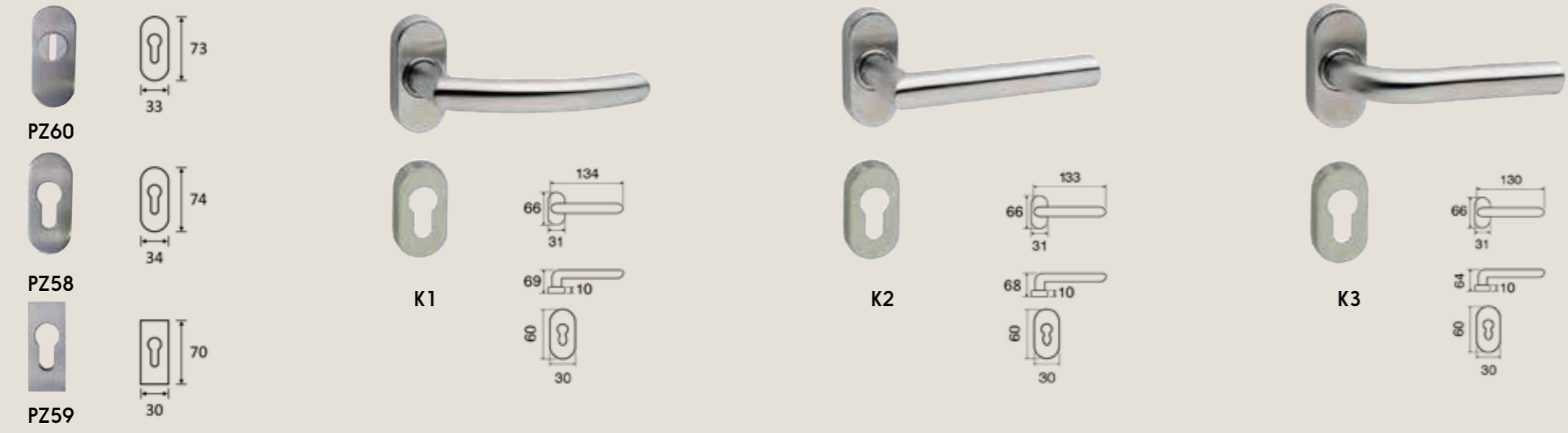

Rozety exteriérové:

Rozmery roziet sú uvedené v milimetroch. Zobrazené rozety sú skladové.

Jednostranné kľučky + interiérové rozety zámkových vložiek:

Rozmery kľučiek sú uvedené v milimetroch. Zobrazené kľučky s rozetami sú skladové.

Materiál a povrch:

Všetky madlá i kľučky sú v prevedení nerez matný -brúsený. Nerez je ušachtitá oceľ, vyznačuje sa vysokou pevnosťou, rozmerovou a povrchovou stálosťou a najmä oteruvzdornosťou.

Exterior plates:

Plate dimensions are specified in millimetres. The shown plates are in stock.

One-sided levers + interior plates of lock cylinders:

Lever dimensions are specified in millimetres. The shown levers with plates are in stock.

Material and surface finish:

All handle bars and levers come with a stainless steel matt-ground finish. Stainless steel is a material of high strength, dimensional and surface stability and good abrasion resistance.

Außen-Rosetten:

Die Rosetten-Abmessungen sind in Millimetern angeführt. Die abgebildeten Rosetten sind im Lager vorrätig.

Einseitige Klinken + Innen-Rosetten von Schließzylindern:

Die Klinkeabmessungen sind in Millimetern angeführt. Die abgebildeten Klinken mit Rosetten sind im Lager vorrätig.

Material und Oberfläche:

Alle Griffe und Klinken kommen in matterter Edelstahl ausführung. Edelstahl ist hochwertiger Stahl, der sich durch hohe Festigkeit, stabile Abmessungen und Oberfläche sowie besondere Verschleißfestigkeit auszeichnet.

Rosettes d'extérieur

Les dimensions des rosettes sont indiquées en millimètres. Les rosettes affichées sont en stock.

Poignées unilatérales + rosettes d'extérieur de cylindres de serrure

Les dimensions des poignées sont indiquées en millimètres. Les poignées affichées avec rosettes sont en stock.

Matériau et surface:

Toutes les barres et poignées sont dans une version inox mat-émerisé. L'inox est un acier enrichi, il se caractérise par une haute résistance, une stabilité dimensionnelle et de surface et, avant tout, sa résistance à l'abrasion.



Prislušenstvo dverných výplní

Aktuálnu ponuku madiel, vonkajšieho kovania, doplnkov, panoramatických priezorov, klopadiel a listových vhodov nájdete na našej stránke www.gavaplast.sk



Door glazing accessories

Our current range of handle bars, exterior fittings, panoramic sight glass, accessories, knockers and letter boxes can be found on our web page. www.gavaplast.com



Zubehör für Türfüllungen

Das aktuelle Angebot an Griffen, Außenbeschlägen, Panorama-Türspionen, Türklopfern und Briefeinwürfen finden Sie auf unserer Webseite. www.gavaplast.eu



Accessoires de panneaux de portes

Vous trouverez sur notre site l'offre actuelle de barres, ferrure d'extérieur, accessoires de vasistas panoramiques, butoirs et entrées de boîtes à lettres. www.gavaplast.be



Sada na údržbu nerezových materiálov

Pre nerez vám odporúčame ochrannú sadu na údržbu nerezových materiálov, ktorá zabezpečuje predlžovanie životnosti nerezového materiálu. Na povrchu nerez sa vďaka slanému a kyslému prostrediu môže objavovať povrchová korózia zapríčinená častočkami cudzích materiálov. Ochrannú sadu môžete použiť aj na iné typy nerezových materiálov určených pre exteriér.

Stainless steel maintenance set

A protective maintenance set is recommended for stainless steel, ensuring the extended service life of the stainless steel material. Salty and acidic environments may result in surface corrosion caused by foreign particles. The protective set may be used for other types of stainless steel materials intended for an exterior environment.

Set zur Pflege von Edelstahlteilen

Wir empfehlen Ihnen ein Set zur Pflege von Edelstahlteilen, das für deren verlängerte Lebensdauer sorgt. Auf der Edelstahloberfläche kann es aufgrund salziger und saurer Umgebung zu Korrosionsbildung kommen, die durch Teilchen von Fremdmaterialien verursacht werden. Das Pflegeset können Sie auch für andere Typen von Edelstahlmaterialien verwenden, die für den Außenbereich bestimmt sind.

Kit d'entretien des matériaux inox

Pour l'inox, nous vous recommandons un kit de protection pour l'entretien des matériaux inox, assurant une prolongation de la durée de vie du matériau inox. Sur la surface de l'inox peut se trouver, du fait d'un environnement salé et acide, une corrosion de surface causée par des particules de matériaux étrangers. Vous pouvez aussi utiliser le kit de protection pour d'autres types de matériaux inox destinés à l'extérieur.



od konceptu ...

k detailu

from concept ...

to detail

Vom Konzept ...

zum Detail

du concept ...

au détail



www.gavaplast.sk
www.gavaplast.com
www.gavaplast.eu
www.gavaplast.be



www.gavaplast.sk/gava-designer
www.gavaplast.com/gava-designer
www.gavaplast.eu/gava-designer
www.gavaplast.be/gava-designer